

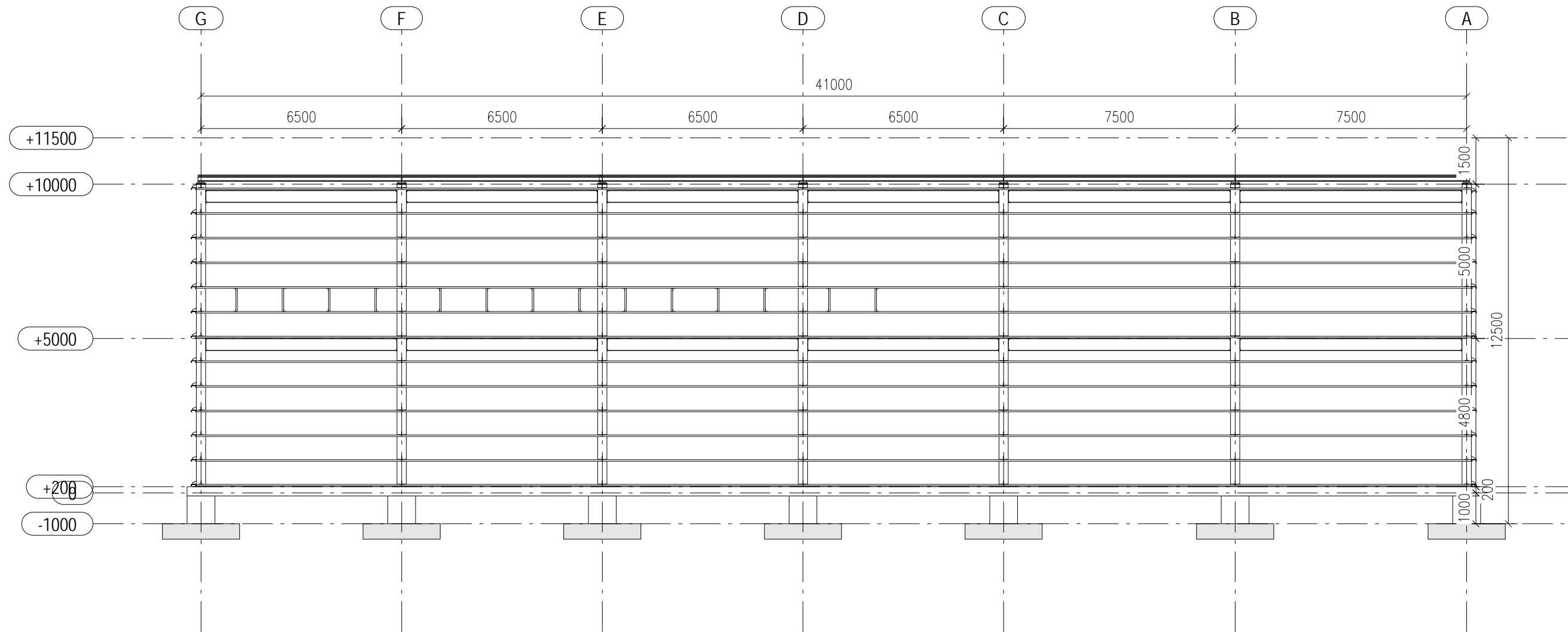

圖面型鋼清單			
代號	規格	材質	數量
	PL4.5*900	A36	7
	RB13	A36	12
M	C150X50X20X2.3	A36	130
M	RH396X199X7X11	SN490B	26
M	RH488X300X11X18	SN490B	7



ERECTION
NORTH

POWERED BY  TEKLA A TRIMBLE COMPANY		馳揚數位科技	
DRAWING TITLE	立面圖@LINE 1		
CONTRACT	順億廠房新建工程B棟		
CONTRACT NO	101	ISSUE DATE	
MODELLED BY	馳揚數位科技	REVISION DATE	
DRAW BY	馳揚數位科技	REVISION No.	
CHECKED	馳揚數位科技	DATE	06.08.2018
	DWG. No.	[1]	

圖面型鋼清單				
代號	規格	材質	數量	
	PL4.5*900	A36	2	
	RB13	A36	4	
M	C150X50X20X2.3	A36	76	
M	RH300X150X6.5X9	SN490B	6	
M	RH396X199X7X11	SN490B	10	
M 7000	RH488X300X11X18	SN490B	2	

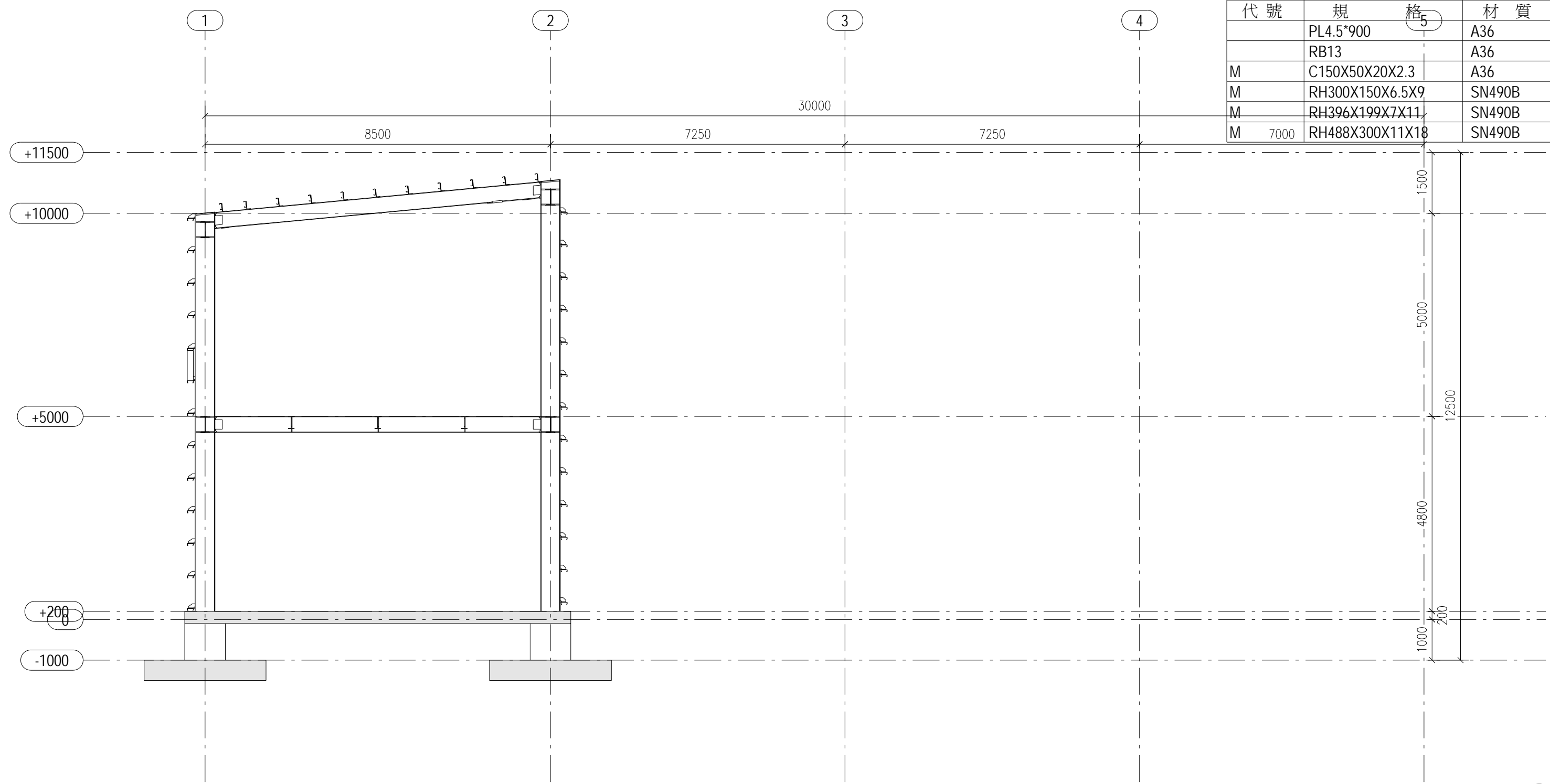

ERECTION NORTH

POWERED BY  A TRIMBLE COMPANY		馳揚數位科技		
DRAWING TITLE	立面圖@LINE E			
CONTRACT	順億廠房新建工程B棟			
CONTRACT NO	101	ISSUE DATE		
MODELLED BY	馳揚數位科技	REVISION DATE		
DRAW BY	馳揚數位科技	REVISION No.		
CHECKED	馳揚數位科技	DATE	06.08.2018	DWG. No. [10]

圖面型鋼清單				
代號	規格	材質	數量	
	PL4.5*900	A36	2	
	RB13	A36	4	
M	C150X50X20X2.3	A36	75	
M	RH300X150X6.5X9	SN490B	6	
M	RH396X199X7X11	SN490B	10	
M	7000 RH488X300X11X18	SN490B	2	

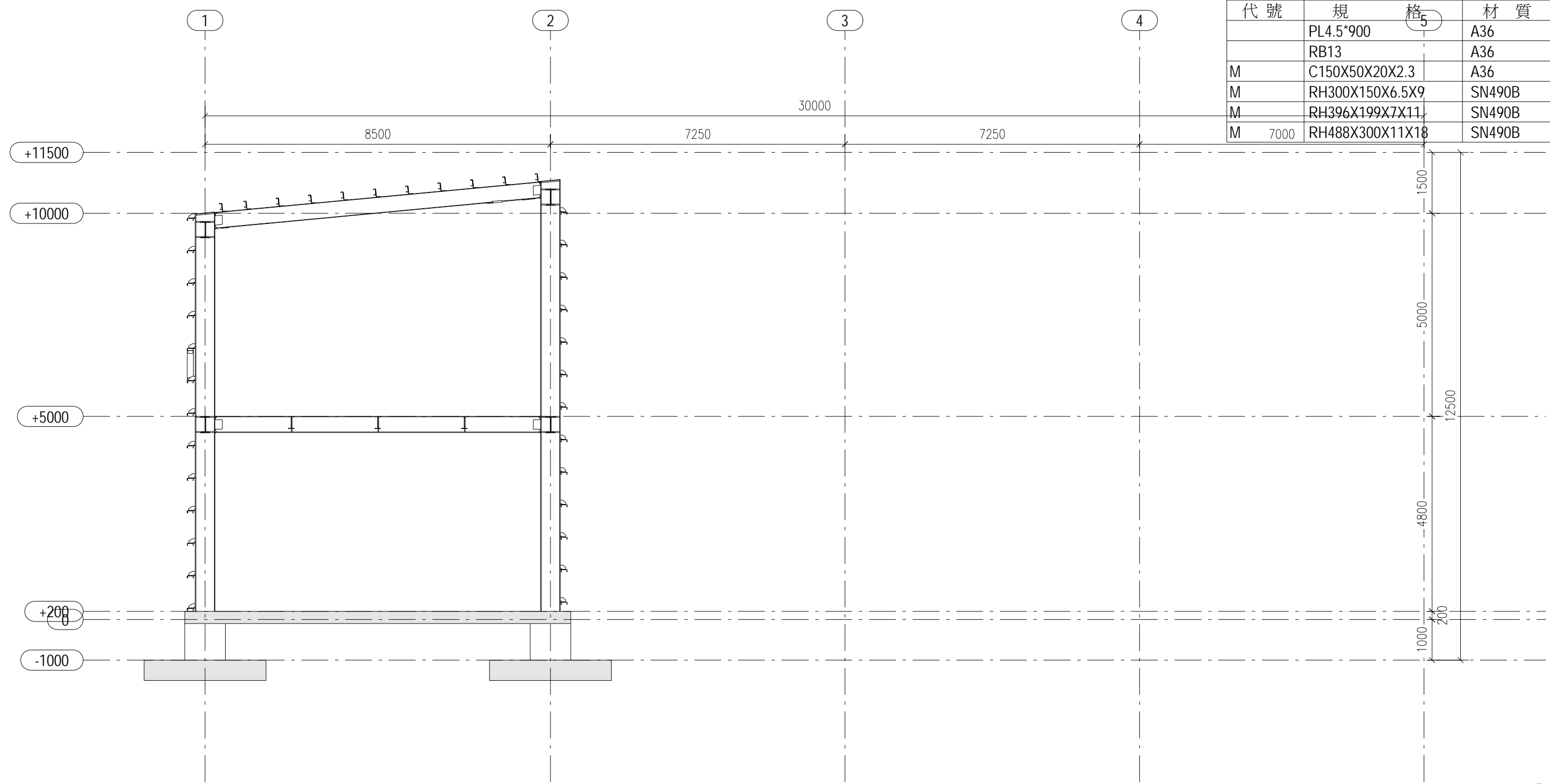

ERECTION
NORTH

POWERED BY  A TRIMBLE COMPANY		馳揚數位科技		
DRAWING TITLE	立面圖@LINE F			
CONTRACT	順億廠房新建工程B棟			
CONTRACT NO	101	ISSUE DATE		
MODELLED BY	馳揚數位科技	REVISION DATE		
DRAW BY	馳揚數位科技	REVISION No.		
CHECKED	馳揚數位科技	DATE	06.08.2018	DWG. No. [11]

圖面型鋼清單				
代號	規格	材質	數量	
	PL4.5*900	A36	2	
	RB13	A36	2	
M	C150X50X20X2.3	A36	57	
M	RH300X150X6.5X9	SN490B	3	
M	RH396X199X7X11	SN490B	6	
M 7000	RH488X300X11X18	SN490B	2	

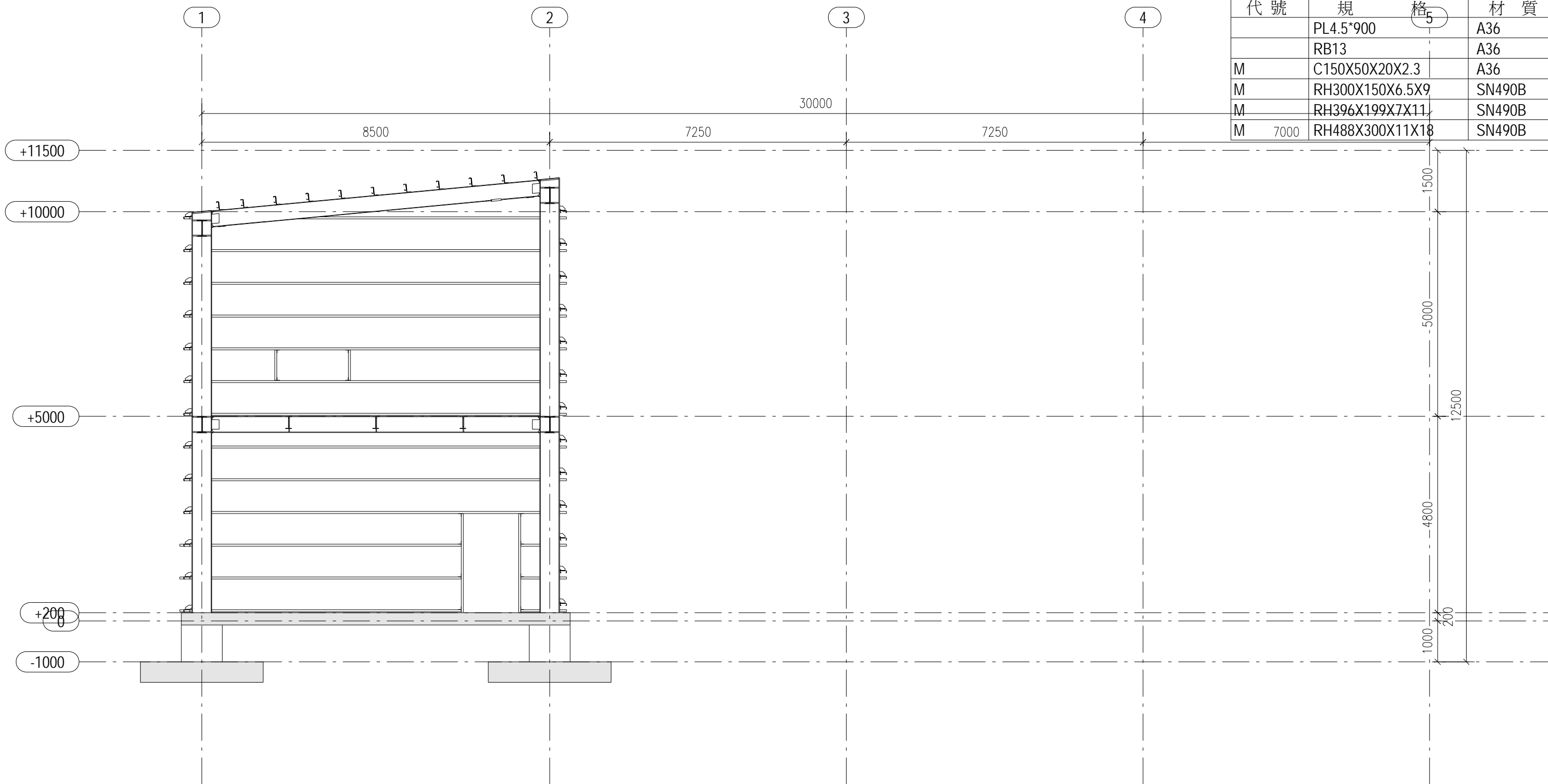

ERECTION
NORTH

POWERED BY		 A TRIMBLE COMPANY		<h2>馳揚數位科技</h2>	
DRAWING TITLE		立面圖@LINE G			
CONTRACT		順億廠房新建工程B棟			
CONTRACT NO	101	ISSUE DATE			
MODELLED BY	馳揚數位科技	REVISION DATE			
DRAW BY	馳揚數位科技	REVISION No.			
CHECKED	馳揚數位科技	DATE	06.08.2018	DWG. No.	[12]

圖面型鋼清單			
代號	規格	材質	數量
A	PL4.5*900	A36	23

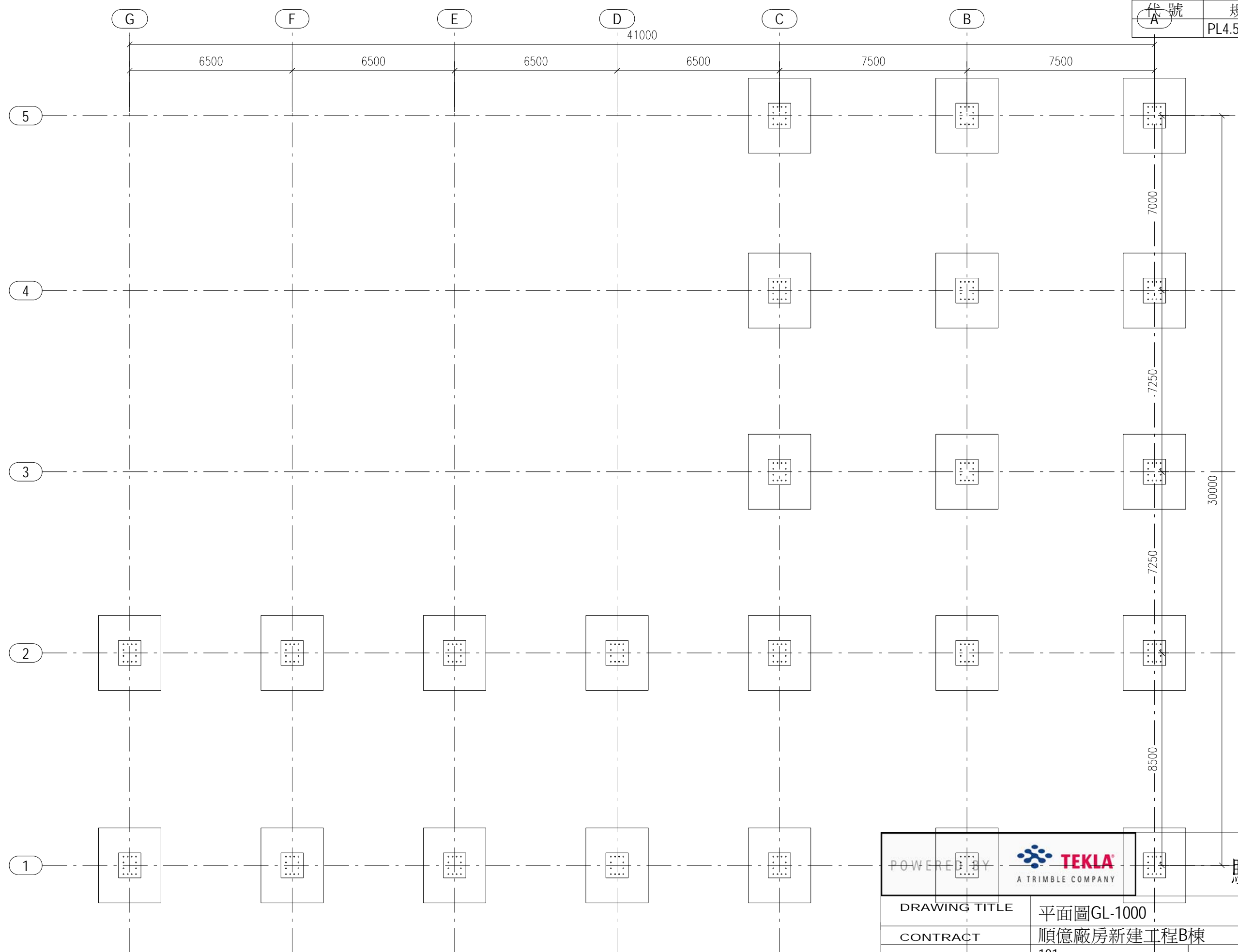

ERECTION
NORTH

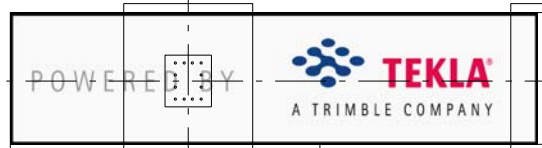

馳揚數位科技

DRAWING TITLE		平面圖GL-1000		
CONTRACT		順億廠房新建工程B棟		
CONTRACT NO	101	ISSUE DATE		
MODELLED BY	馳揚數位科技	REVISION DATE		
DRAW BY	馳揚數位科技	REVISION No.		
CHECKED	馳揚數位科技	DATE	06.08.2018	DWG. No. [13]

圖面型鋼清單			
代號	規格	材質	數量
A	PL4.5*900	A36	23
	PL12*350	A36	1
M	C150X50X20X2.3	A36	26
M	RH488X300X11X18	SN490B	23

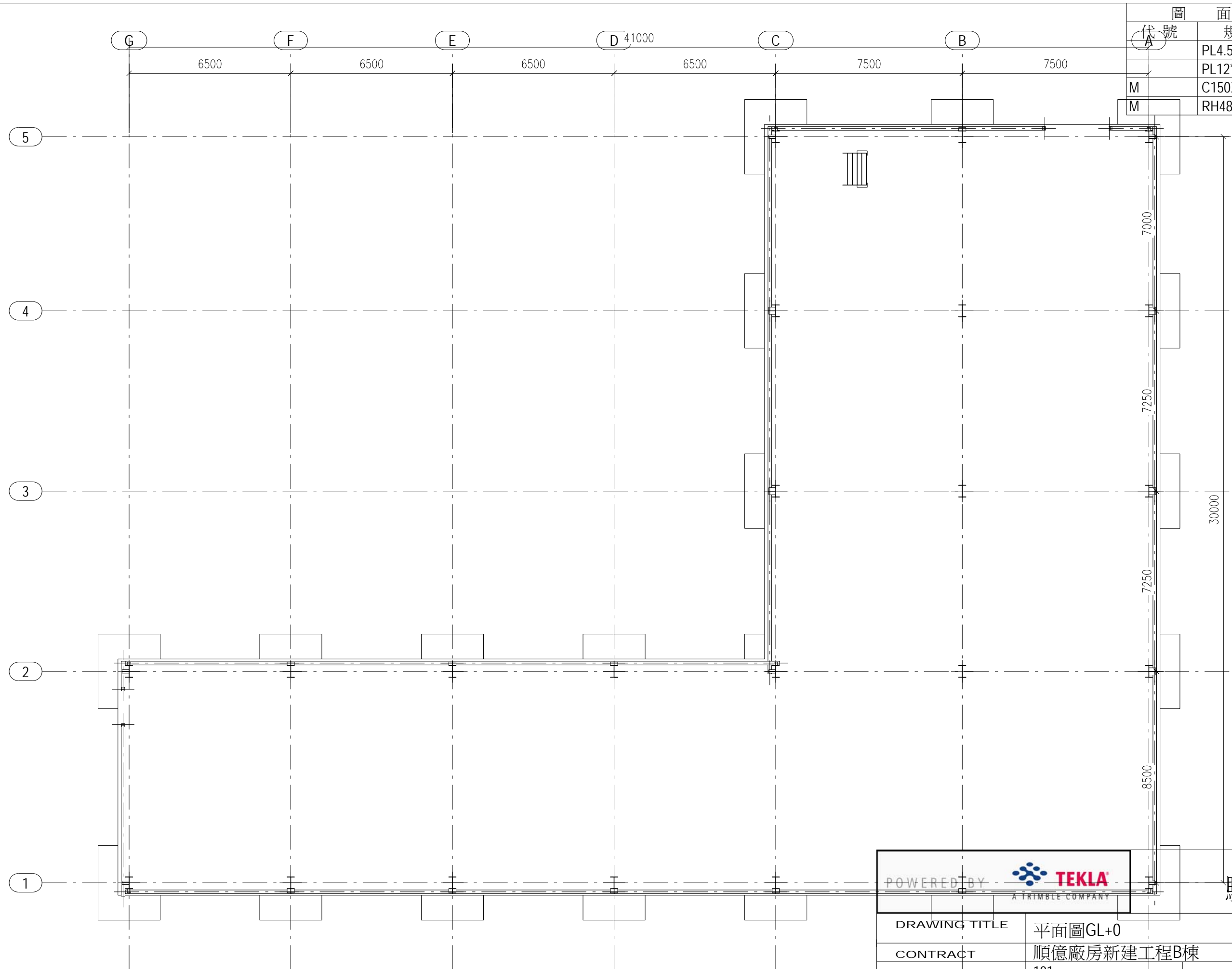

ERECTION NORTH

馳揚數位科技



DRAWING TITLE		平面圖GL+0		
CONTRACT		順億廠房新建工程B棟		
CONTRACT NO	101	ISSUE DATE		
MODELLED BY	馳揚數位科技	REVISION DATE		
DRAW BY	馳揚數位科技	REVISION No.		
CHECKED	馳揚數位科技	DATE	06.08.2018	DWG. No. [14]

圖面型鋼清單			
代號	規格	材質	數量
A	PL4.5*900	A36	23
	PL12*350	A36	1
M	C150X50X20X2.3	A36	52
M	RH488X300X11X18	SN490B	23

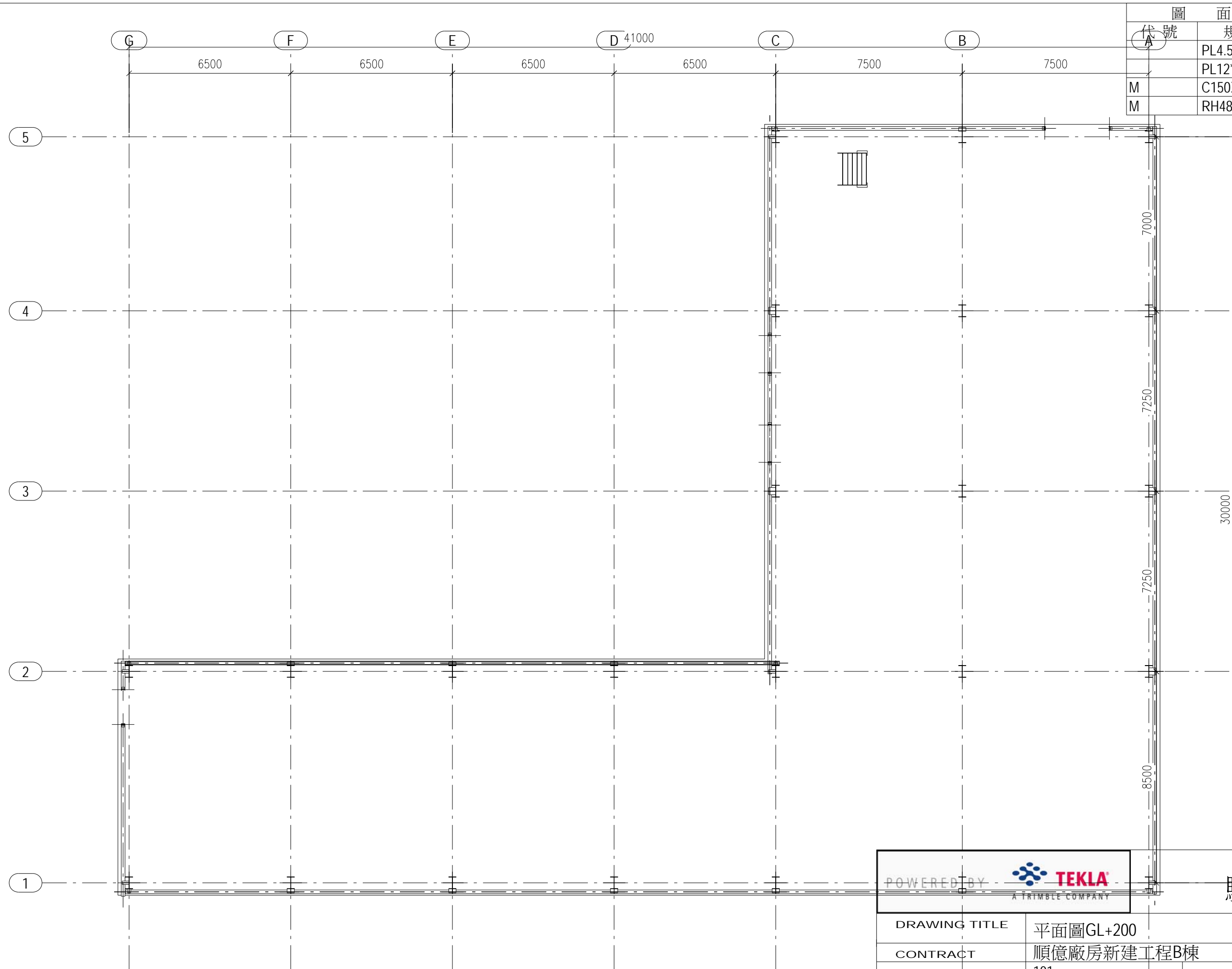

ERECTION
NORTH



馳揚數位科技

DRAWING TITLE	平面圖GL+200			
CONTRACT	順億廠房新建工程B棟			
CONTRACT NO	101	ISSUE DATE		
MODELLED BY	馳揚數位科技	REVISION DATE		
DRAW BY	馳揚數位科技	REVISION No.		
CHECKED	馳揚數位科技	DATE	06.08.2018	DWG. No. [15]

圖面型鋼清單			
代號	規格	材質	數量
A	PL12*350	A36	1
M	C150X50X20X2.3	A36	94
M	RH300X150X6.5X9	SN490B	31
M	RH396X199X7X11	SN490B	40
M	RH488X300X11X18	SN490B	23

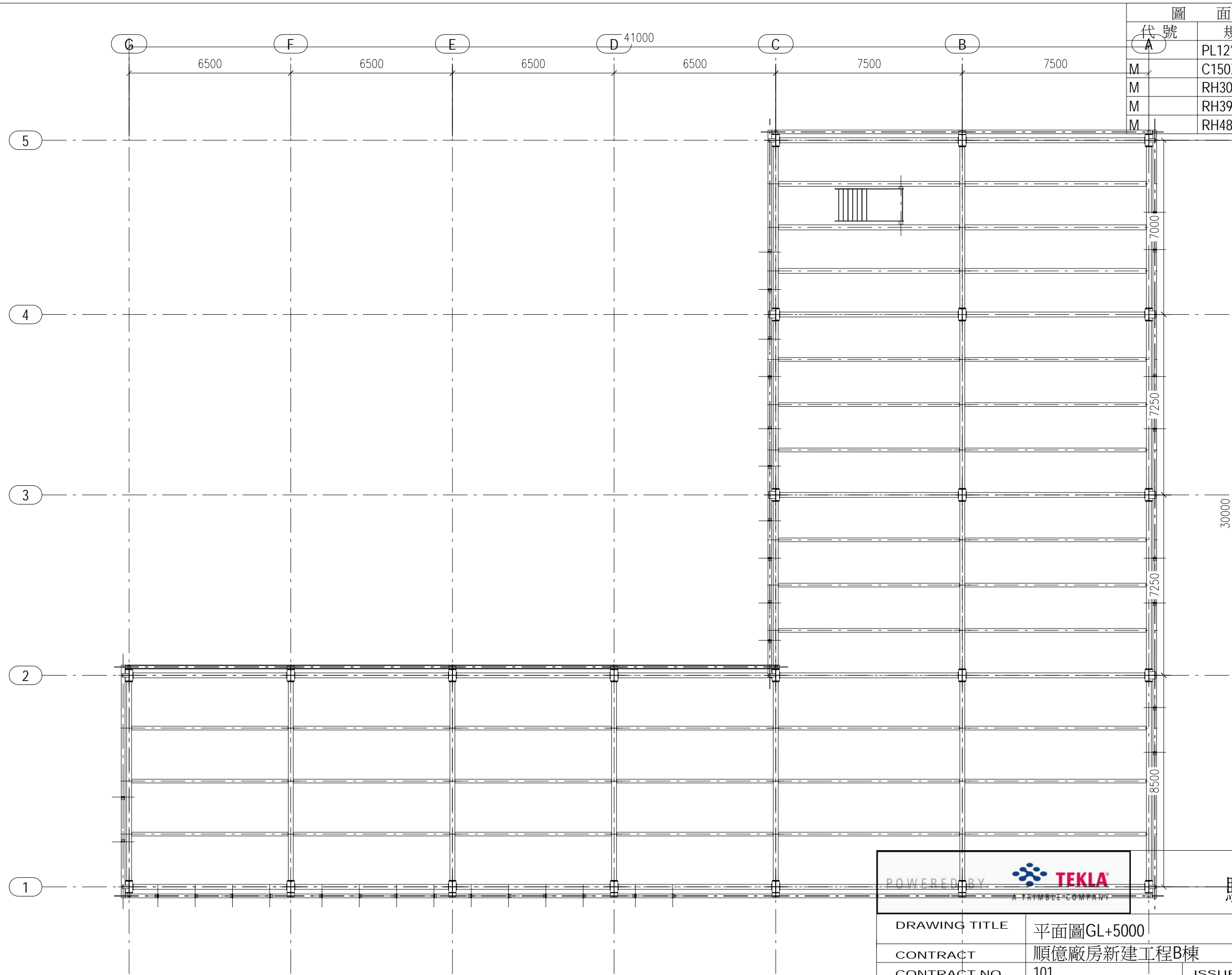

ERECTION NORTH

馳揚數位科技



DRAWING TITLE	平面圖GL+5000		
CONTRACT	順億廠房新建工程B棟		
CONTRACT NO	101	ISSUE DATE	
MODELLED BY	馳揚數位科技	REVISION DATE	
DRAW BY	馳揚數位科技	REVISION No.	
CHECKED	馳揚數位科技	DATE	06.08.2018
		DWG. No.	[16]

圖面型鋼清單			
代號	規格	材質	數量
A	RB13	A36	24
M	C150X50X20X2.3	A36	136
M	RH396X199X7X11	SN490B	34
M	RH488X300X11X18	SN490B	23

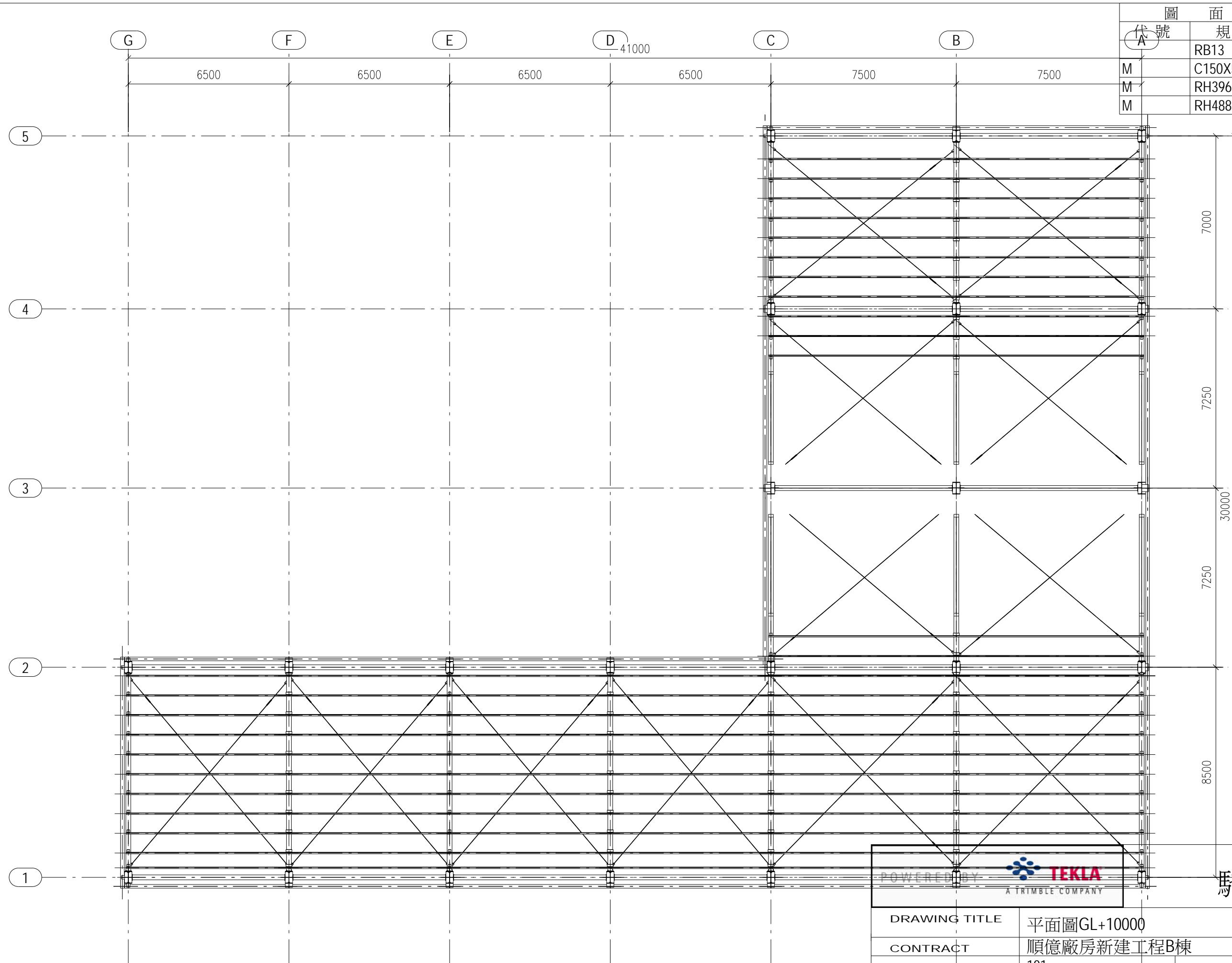

7000
7250
30000
7250
8500



ERECTION NORTH

馳揚數位科技



DRAWING TITLE		平面圖GL+10000		
CONTRACT		順億廠房新建工程B棟		
CONTRACT NO	101	ISSUE DATE		
MODELLED BY	馳揚數位科技	REVISION DATE		
DRAW BY	馳揚數位科技	REVISION No.		
CHECKED	馳揚數位科技	DATE	06.08.2018	DWG. No. [17]

圖面型鋼清單			
代號	規格	材質	數量
A	RB13	A36	8
M	C150X50X20X2.3	A36	92
M	RH396X199X7X11	SN490B	26
M	RH488X300X11X18	SN490B	13

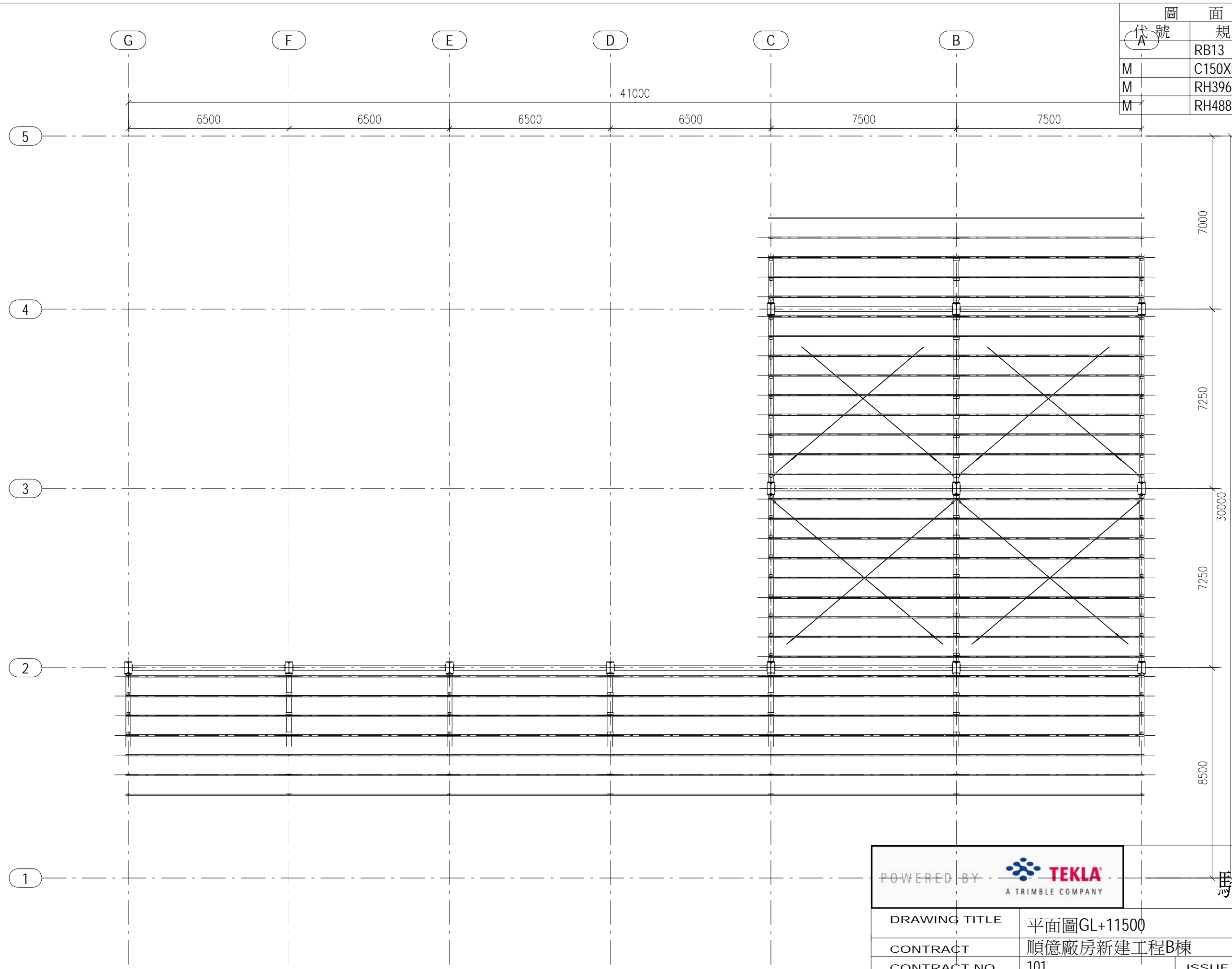

ERECTION NORTH



馳揚數位科技

DRAWING TITLE		平面圖GL+11500		
CONTRACT		順億廠房新建工程B棟		
CONTRACT NO	101	ISSUE DATE		
MODELLED BY	馳揚數位科技	REVISION DATE		
DRAW BY	馳揚數位科技	REVISION No.		
CHECKED	馳揚數位科技	DATE	06.08.2018	DWG. No. [18]

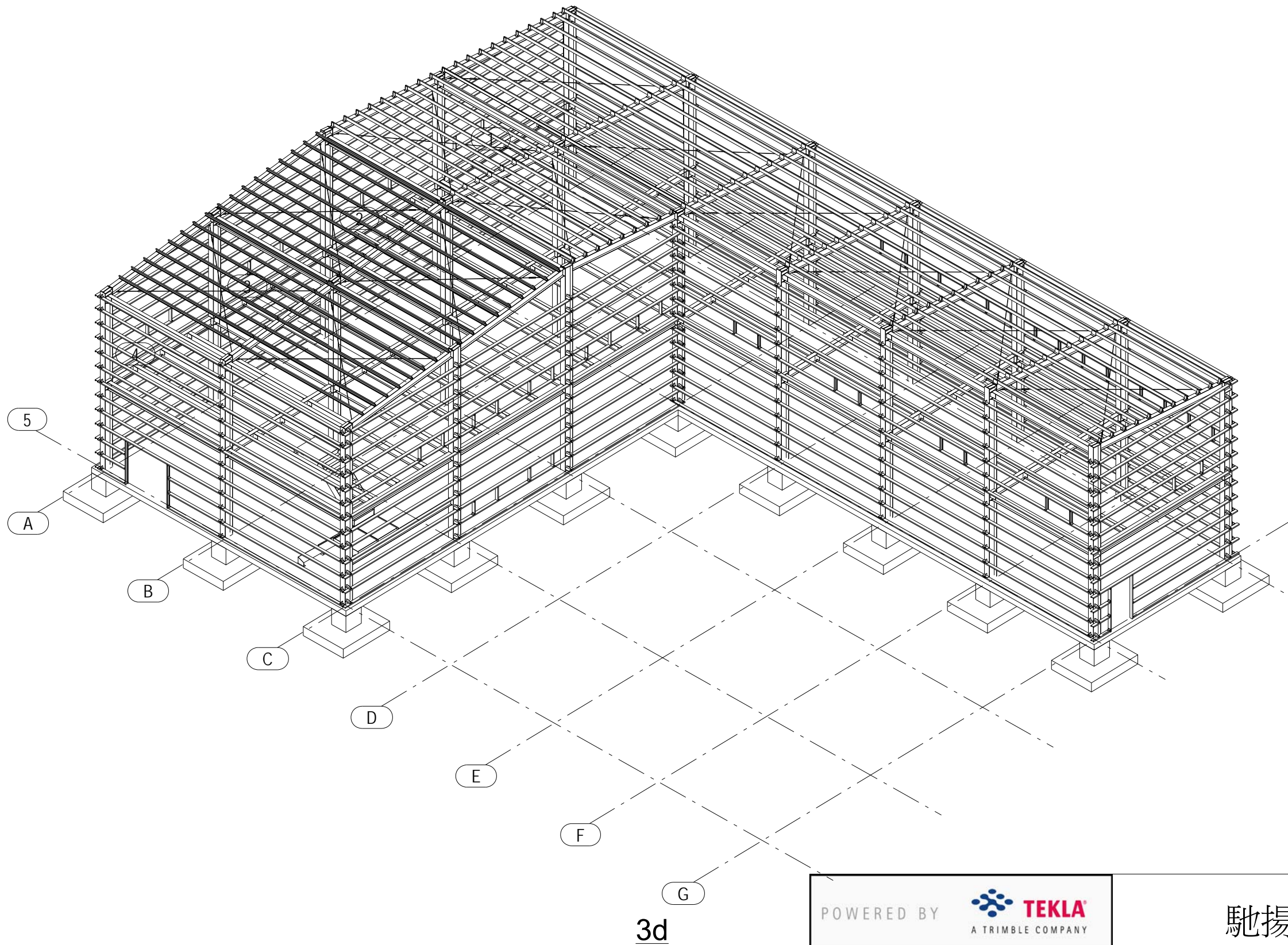

POWERED BY  **TEKLA**
A TRIMBLE COMPANY

馳揚數位科技

DRAWING TITLE	立體圖			
CONTRACT	順億廠房新建工程B棟			
CONTRACT NO	101	ISSUE DATE		
MODELLED BY	馳揚數位科技	REVISION DATE		
DRAW BY	馳揚數位科技	REVISION No.		
CHECKED	馳揚數位科技	DATE	06.08.2018	DWG. No. [19]

圖面型鋼清單			
代號	規格	材質	數量
	PL4.5*900	A36	7
	RB13	A36	16
M	C150X50X20X2.3	A36	125
M	RH396X199X7X11	SN490B	32
M	RH488X300X11X18	SN490B	7

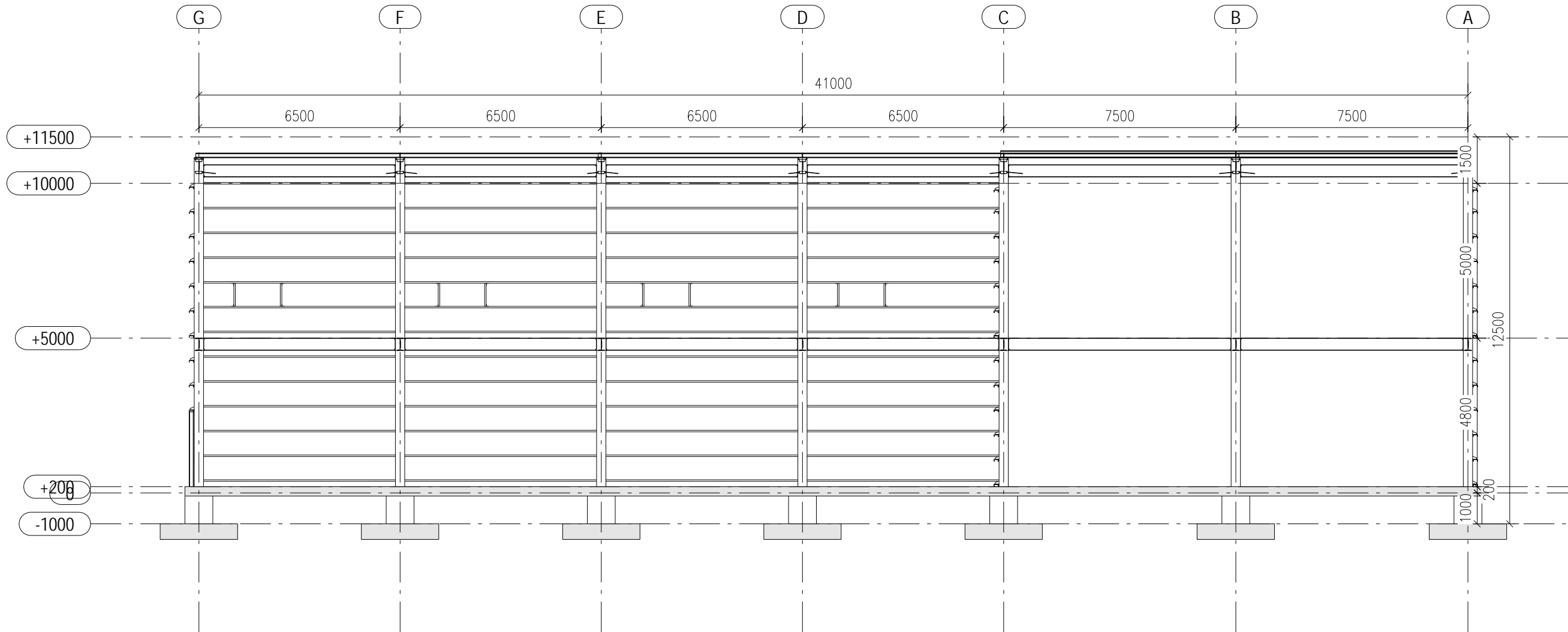

ERECTION
NORTH

POWERED BY  TEKLA A TRIMBLE COMPANY		馳揚數位科技	
DRAWING TITLE	立面圖@LINE 2		
CONTRACT	順億廠房新建工程B棟		
CONTRACT NO	101	ISSUE DATE	
MODELLED BY	馳揚數位科技	REVISION DATE	
DRAW BY	馳揚數位科技	REVISION No.	
CHECKED	馳揚數位科技	DATE	06.08.2018
		DWG. No.	[2]

圖面型鋼清單			
代號	規格	材質	數量
	PL4.5*900	A36	1
M	C150X50X20X2.3	A36	2
M	RH488X300X11X18	SN490B	1

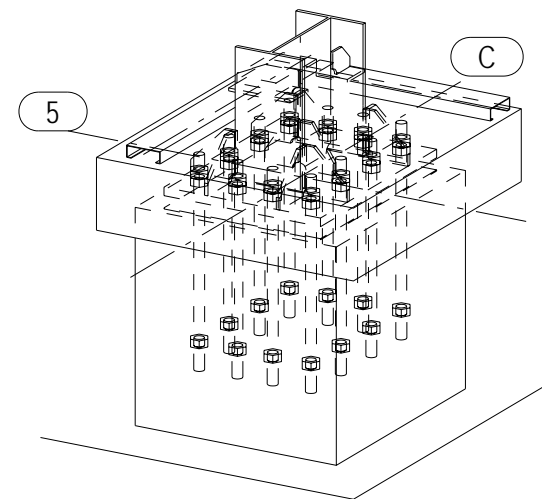
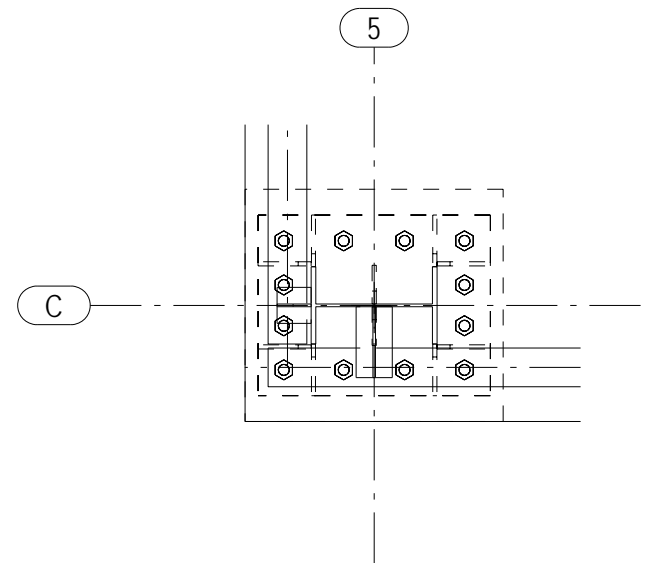
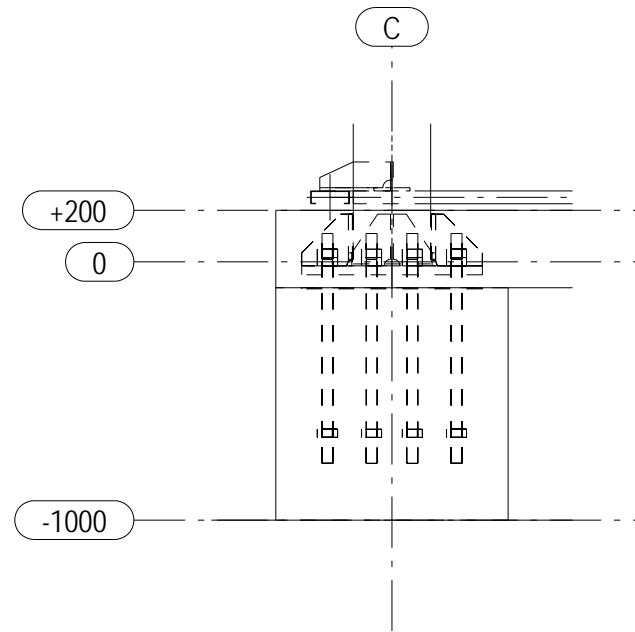
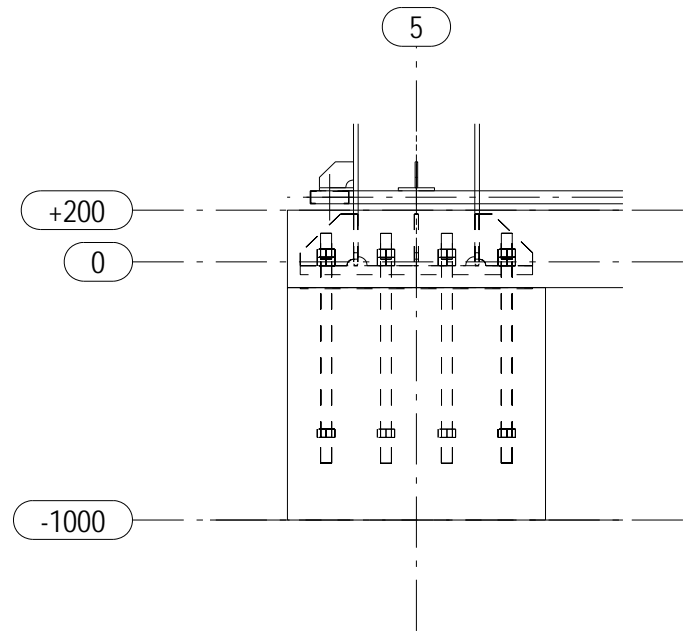

ERECTION
NORTH

POWERED BY  A TRIMBLE COMPANY		馳揚數位科技		
DRAWING TITLE	柱頭詳圖			
CONTRACT	順億廠房新建工程B棟			
CONTRACT NO	101	ISSUE DATE		
MODELLED BY	馳揚數位科技	REVISION DATE		
DRAW BY	馳揚數位科技	REVISION No.		
CHECKED	馳揚數位科技	DATE	06.08.2018	DWG. No. [20]

圖面型鋼清單			
代號	規格	材質	數量
M	C150X50X20X2.3	A36	4
M	RH396X199X7X11	SN490B	3
M	RH488X300X11X18	SN490B	1

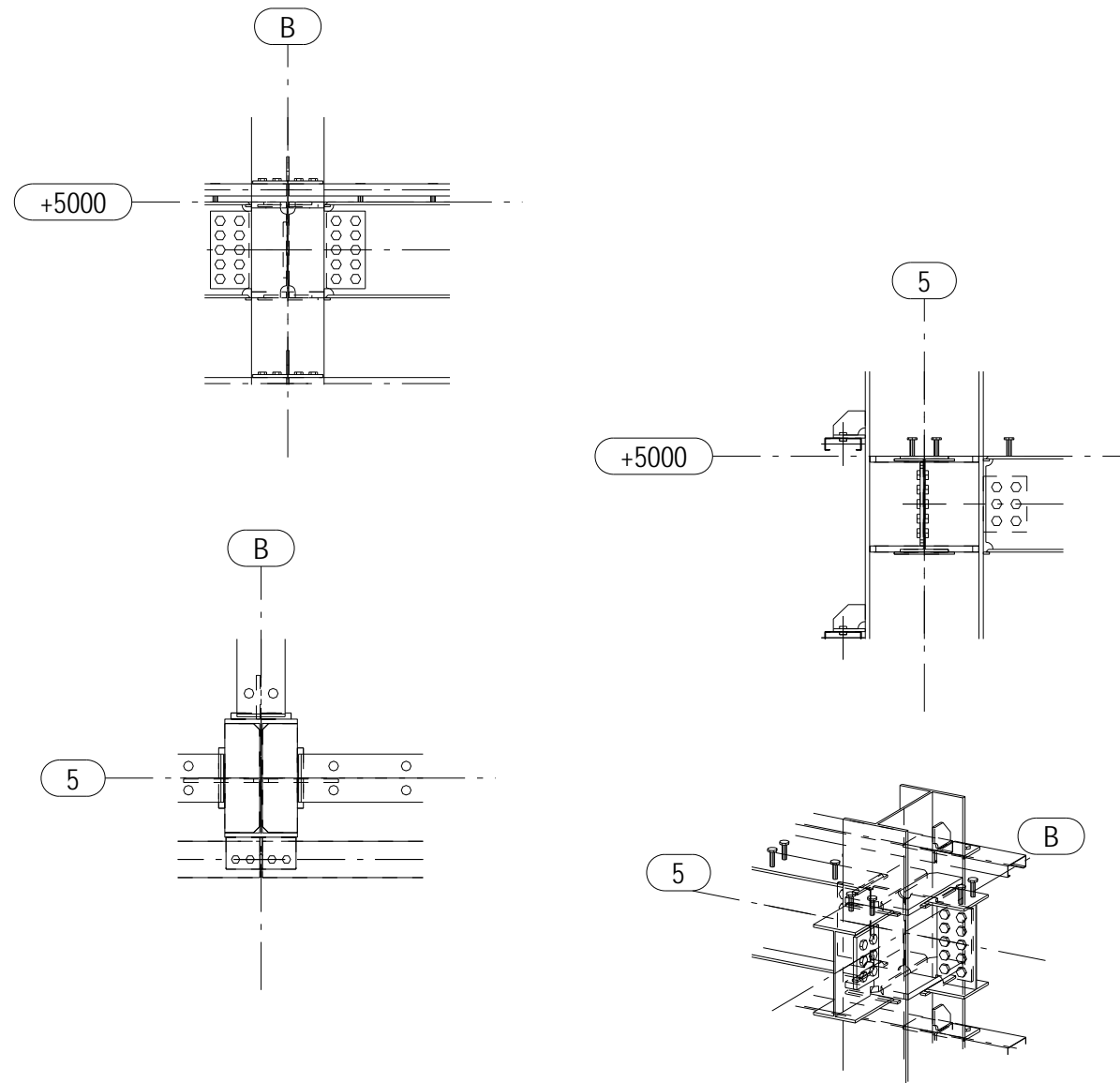

ERECTION
NORTH

POWERED BY  TEKLA A TRIMBLE COMPANY		馳揚數位科技		
DRAWING TITLE	梁柱詳圖(腹版側)			
CONTRACT	順億廠房新建工程B棟			
CONTRACT NO	101	ISSUE DATE		
MODELLED BY	馳揚數位科技	REVISION DATE		
DRAW BY	馳揚數位科技	REVISION No.		
CHECKED	馳揚數位科技	DATE	06.08.2018	DWG. No. [21]

圖面型鋼清單			
代號	規格	材質	數量
M	C150X50X20X2.3	A36	4
M	RH396X199X7X11	SN490B	3
M	RH488X300X11X18	SN490B	1

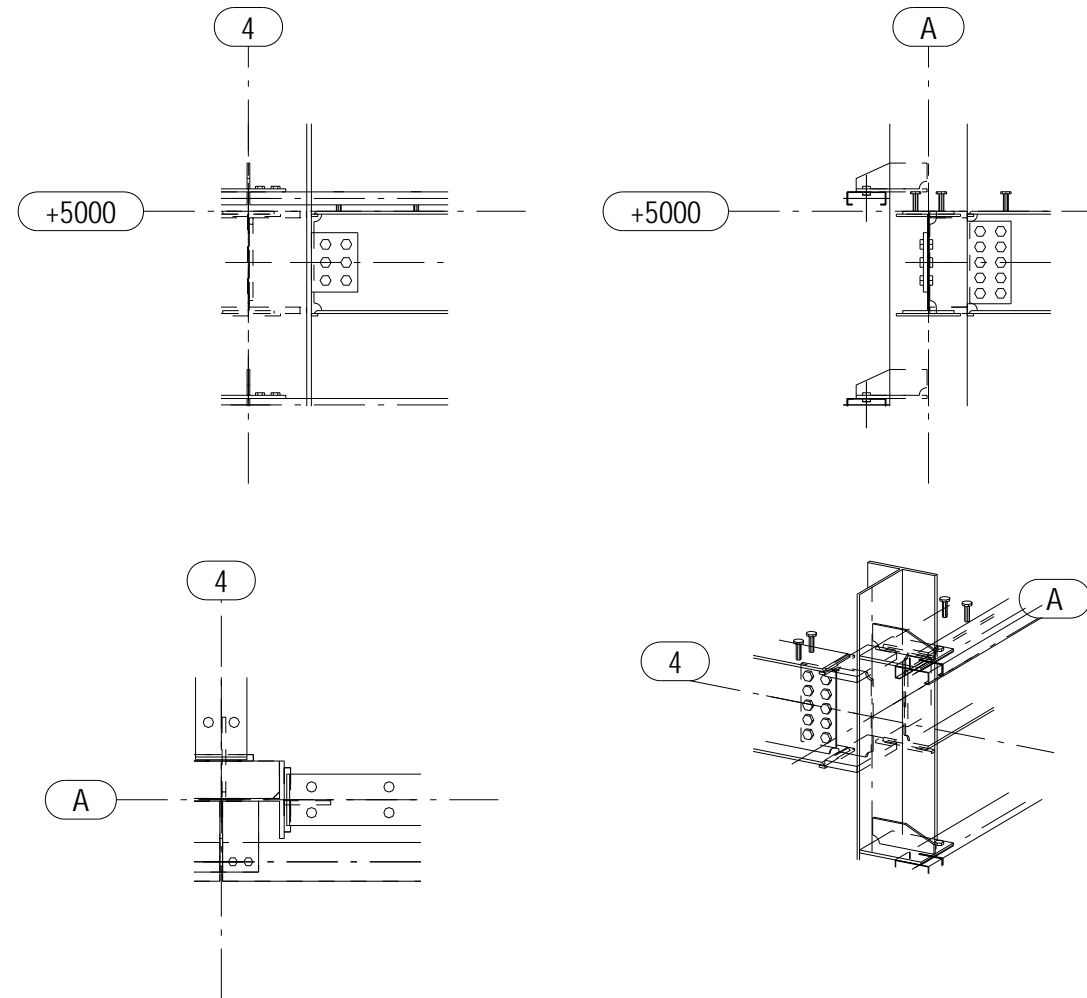

ERECTION
NORTH

POWERED BY  TEKLA A TRIMBLE COMPANY		馳揚數位科技			
DRAWING TITLE		梁柱詳圖(翼版側)			
CONTRACT		順億廠房新建工程B棟			
CONTRACT NO	101	ISSUE DATE			
MODELLED BY	馳揚數位科技	REVISION DATE			
DRAW BY	馳揚數位科技	REVISION No.			
CHECKED	馳揚數位科技	DATE	06.08.2018	DWG. No.	[22]

圖面型鋼清單			
代號	規格	材質	數量
	PL4.5*900	A36	1
	PL12*350	A36	2
M	C150X50X20X2.3	A36	4
M	RH300X150X6.5X9	SN490B	1
M	RH488X300X11X18	SN490B	1

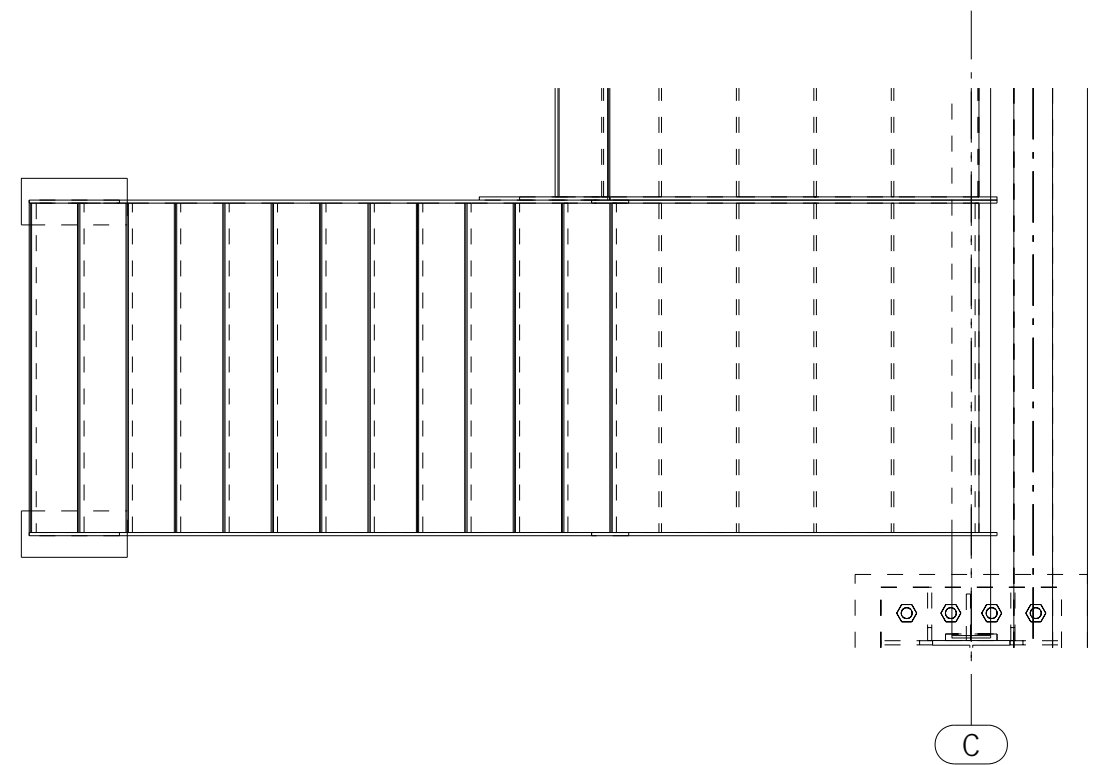
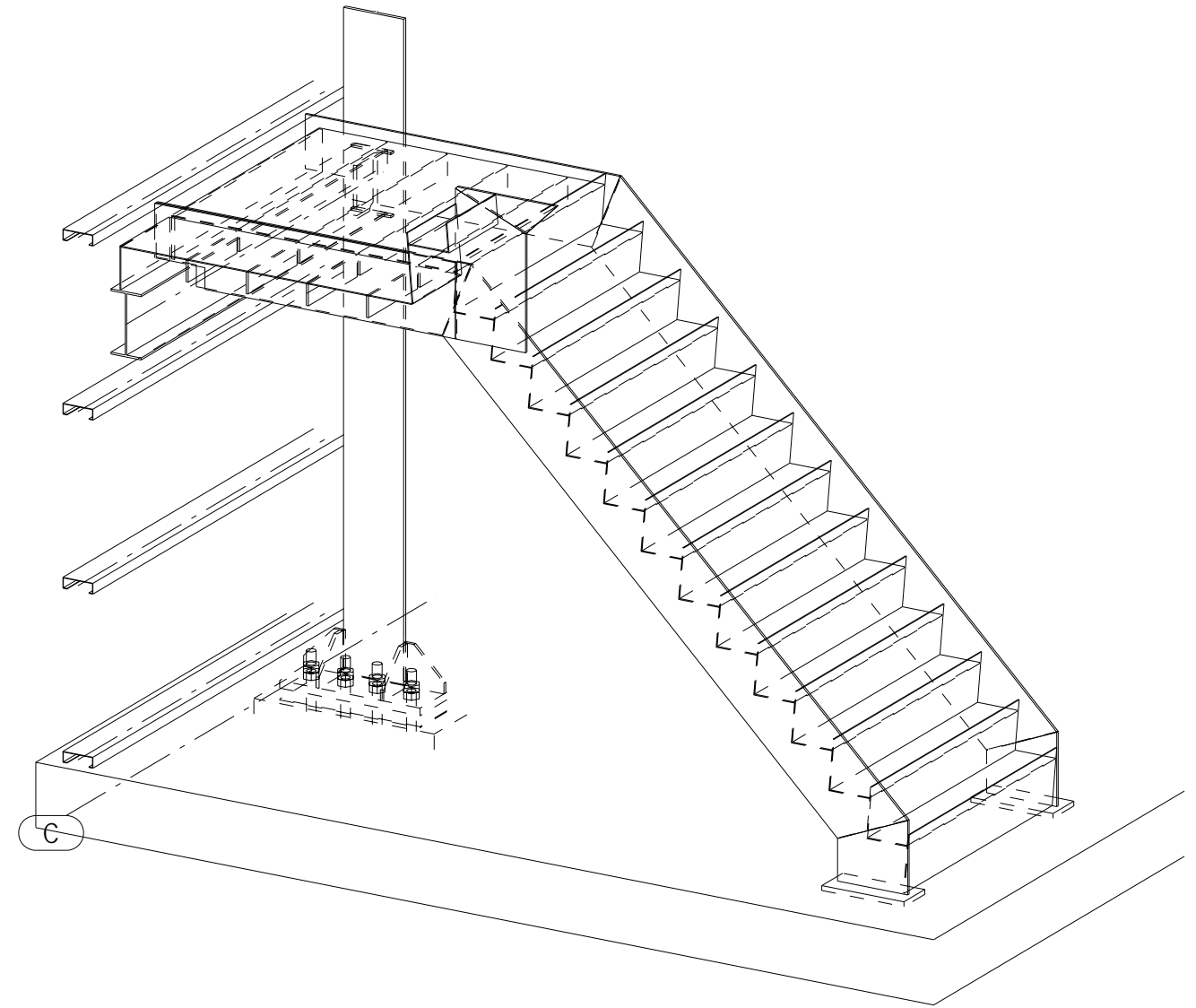
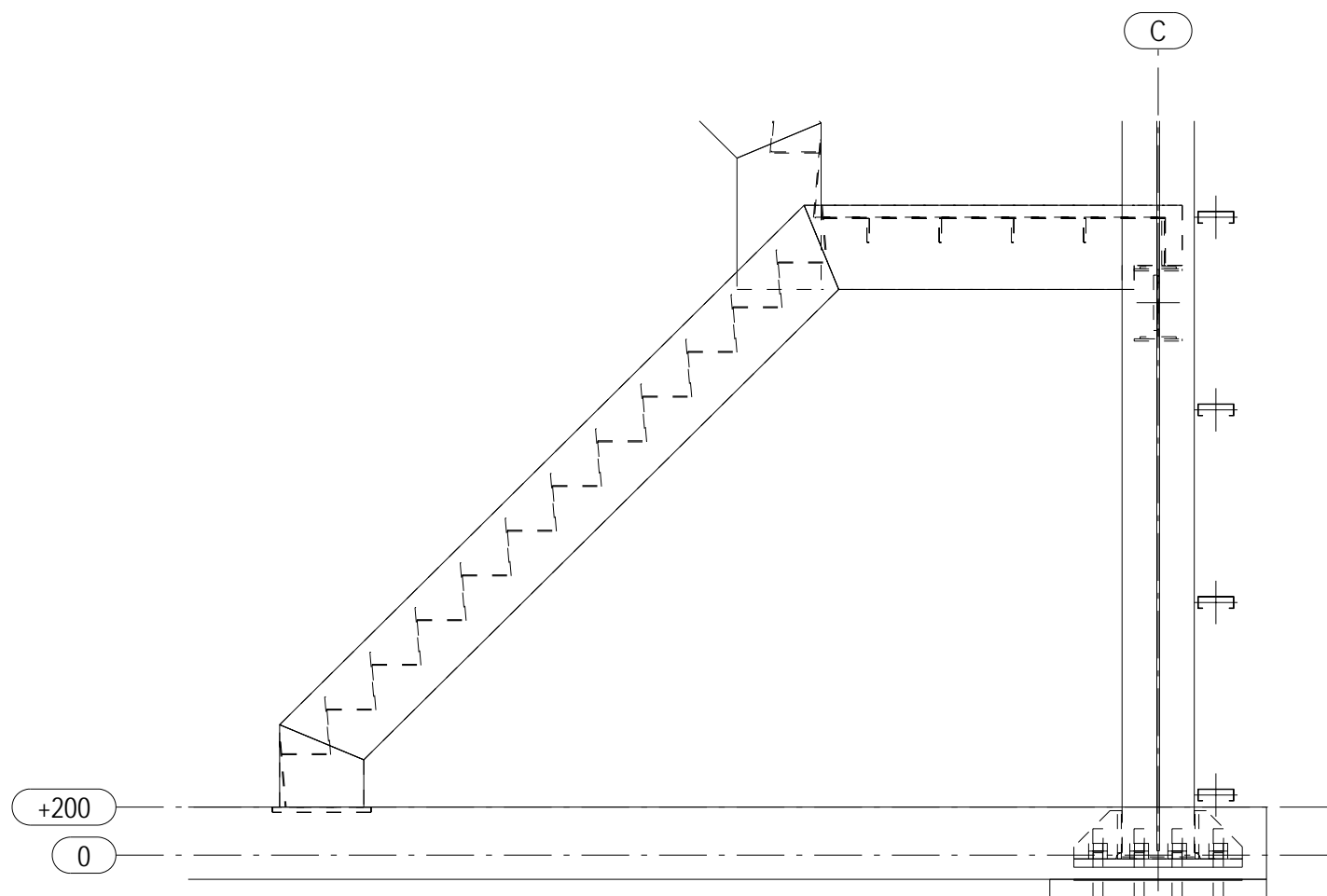

ERECTION NORTH

POWERED BY 		馳揚數位科技			
DRAWING TITLE		樓梯(A)			
CONTRACT		順億廠房新建工程B棟			
CONTRACT NO	101	ISSUE DATE			
MODELLED BY	馳揚數位科技	REVISION DATE			
DRAW BY	馳揚數位科技	REVISION No.			
CHECKED	馳揚數位科技	DATE	06.08.2018	DWG. No.	[23]

圖面型鋼清單			
代號	規格	材質	數量
	PL12*350	A36	2
M	C150X50X20X2.3	A36	4
M	RH300X150X6.5X9	SN490B	2
M	RH396X199X7X11	SN490B	3

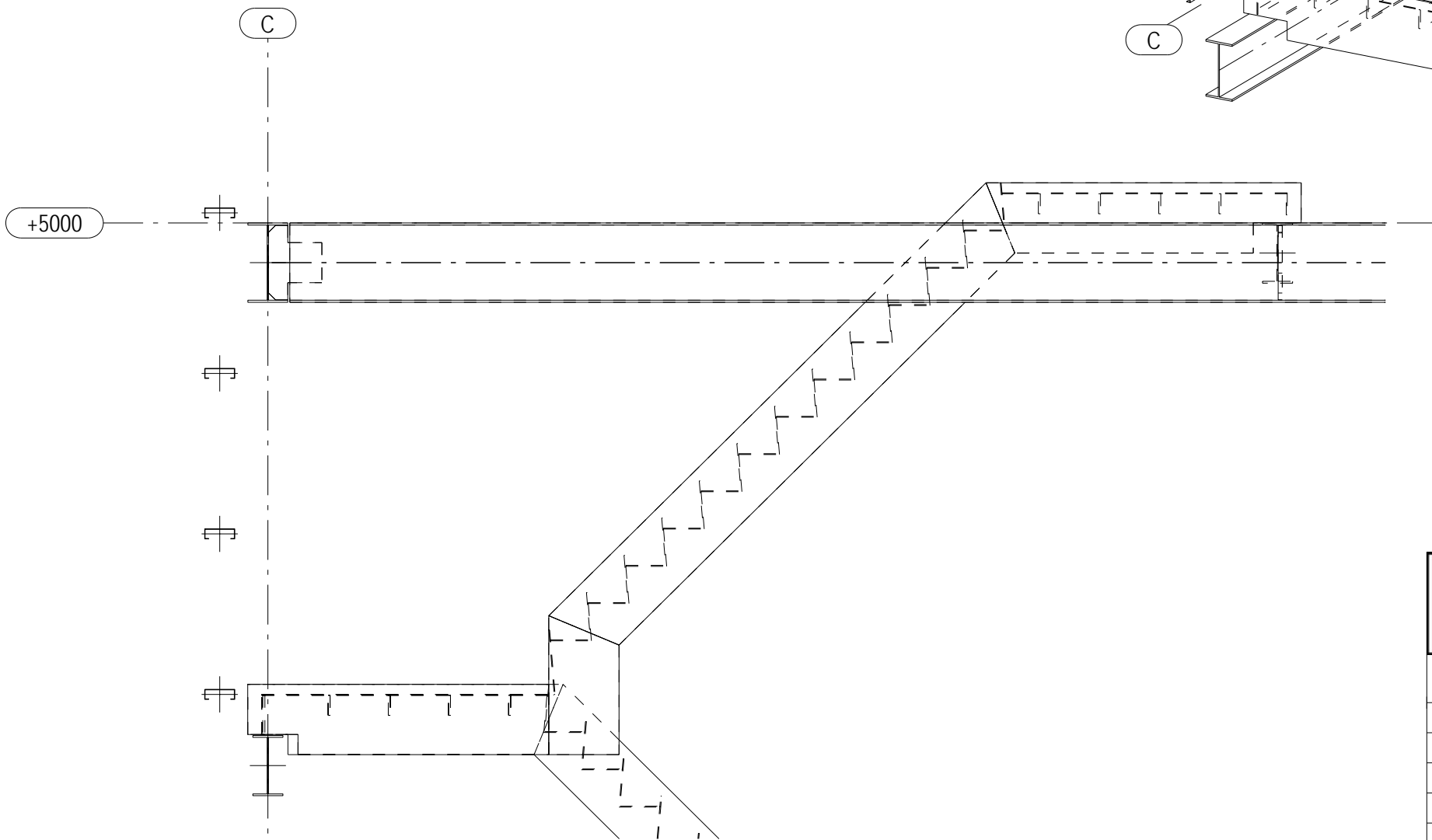
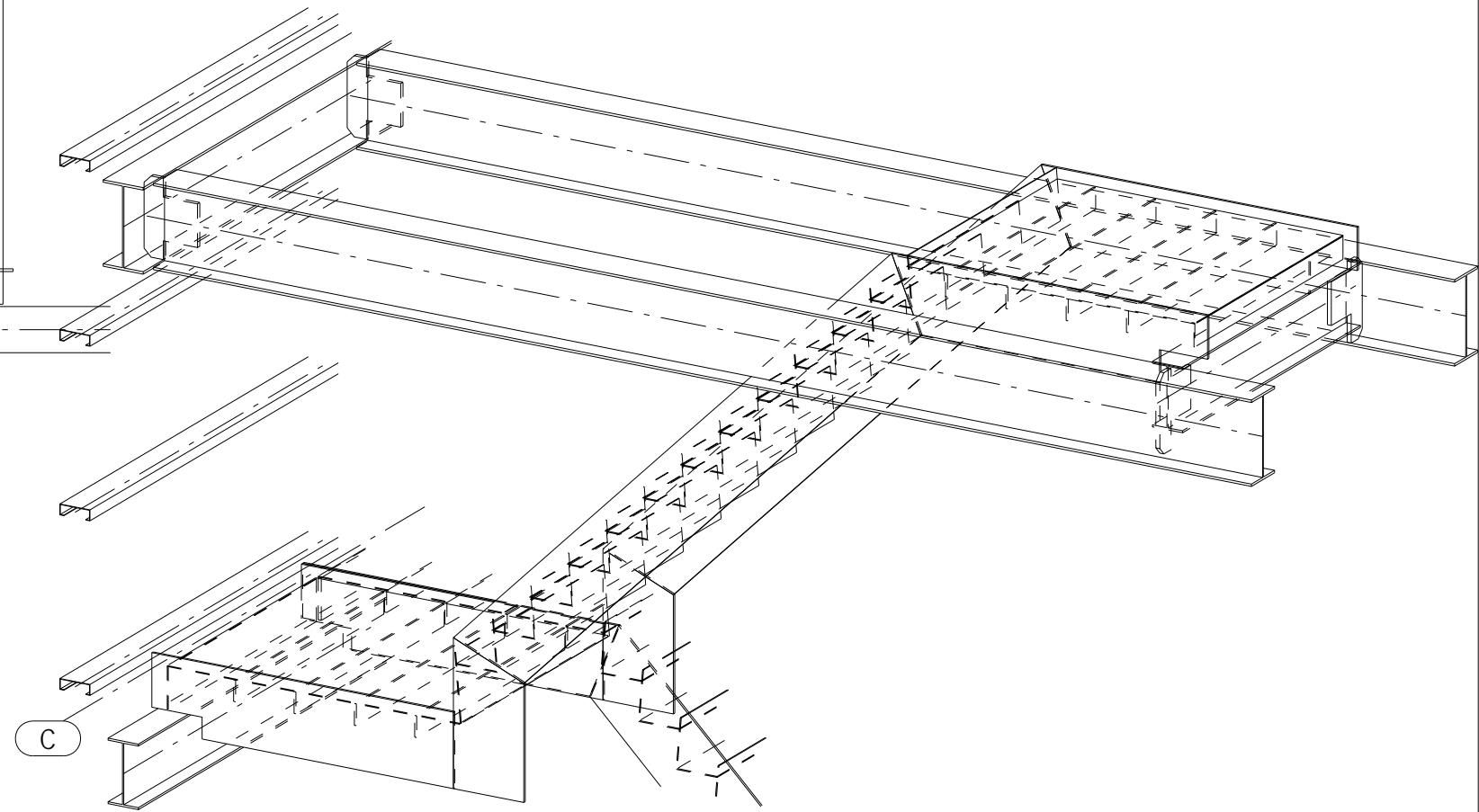
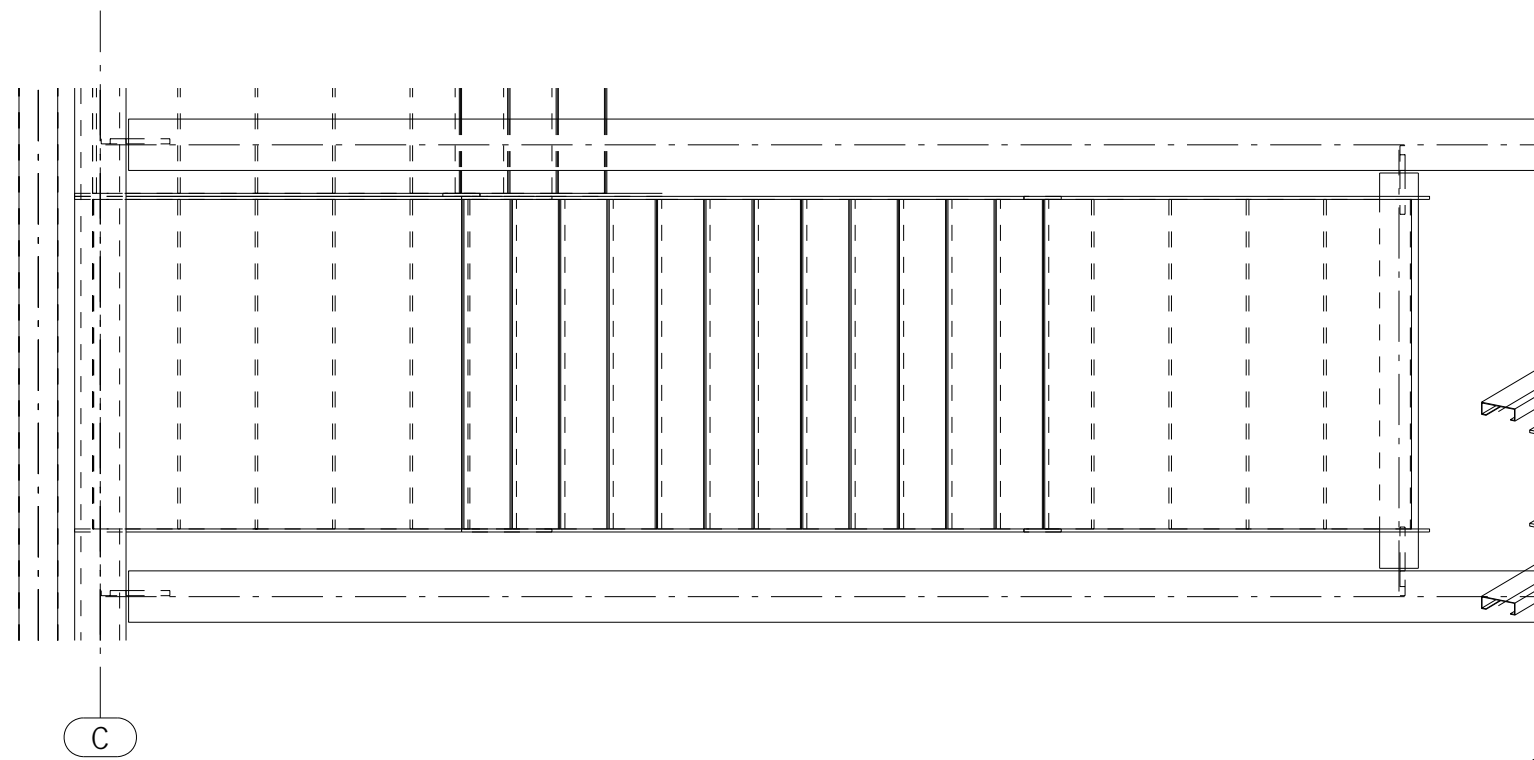

ERECTION
NORTH

POWERED BY  TEKLA A TRIMBLE COMPANY		馳揚數位科技			
DRAWING TITLE		樓梯(B)			
CONTRACT		順億廠房新建工程B棟			
CONTRACT NO	101	ISSUE DATE			
MODELLED BY	馳揚數位科技	REVISION DATE			
DRAW BY	馳揚數位科技	REVISION No.			
CHECKED	馳揚數位科技	DATE	06.08.2018	DWG. No.	[24]

圖面型鋼清單			
代號	規格	材質	數量
	PL4.5*900	A36	3
	RB13	A36	8
M	C150X50X20X2.3	A36	57
M	RH396X199X7X11	SN490B	16
M	RH488X300X11X18	SN490B	3

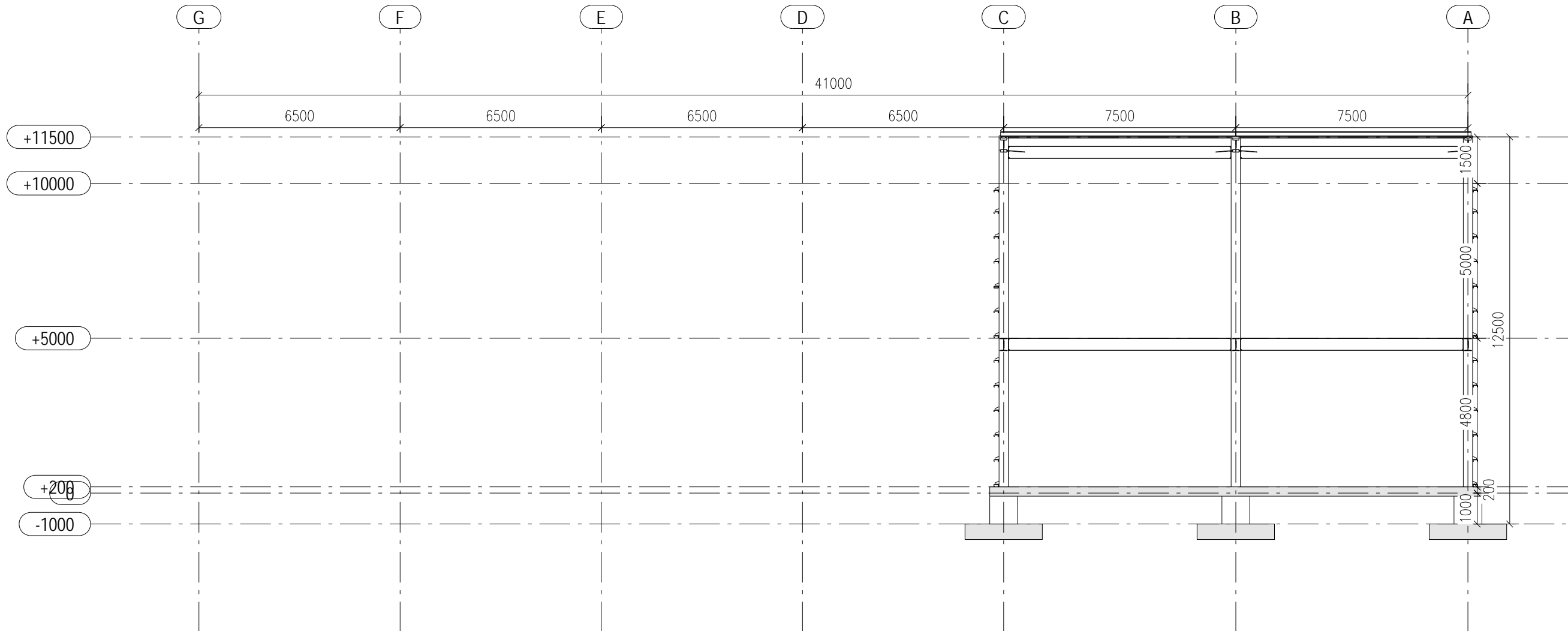

ERECTION
NORTH

POWERED BY  TEKLA A TRIMBLE COMPANY		馳揚數位科技	
DRAWING TITLE		立面圖@LINE 3	
CONTRACT		順億廠房新建工程B棟	
CONTRACT NO	101	ISSUE DATE	
MODELLED BY	馳揚數位科技	REVISION DATE	
DRAW BY	馳揚數位科技	REVISION No.	
CHECKED	馳揚數位科技	DATE	06.08.2018
		DWG. No.	[3]

圖面型鋼清單			
代號	規格	材質	數量
	PL4.5*900	A36	3
	RB13	A36	8
M	C150X50X20X2.3	A36	59
M	RH300X150X6.5X9	SN490B	1
M	RH396X199X7X11	SN490B	16
M	RH488X300X11X18	SN490B	3

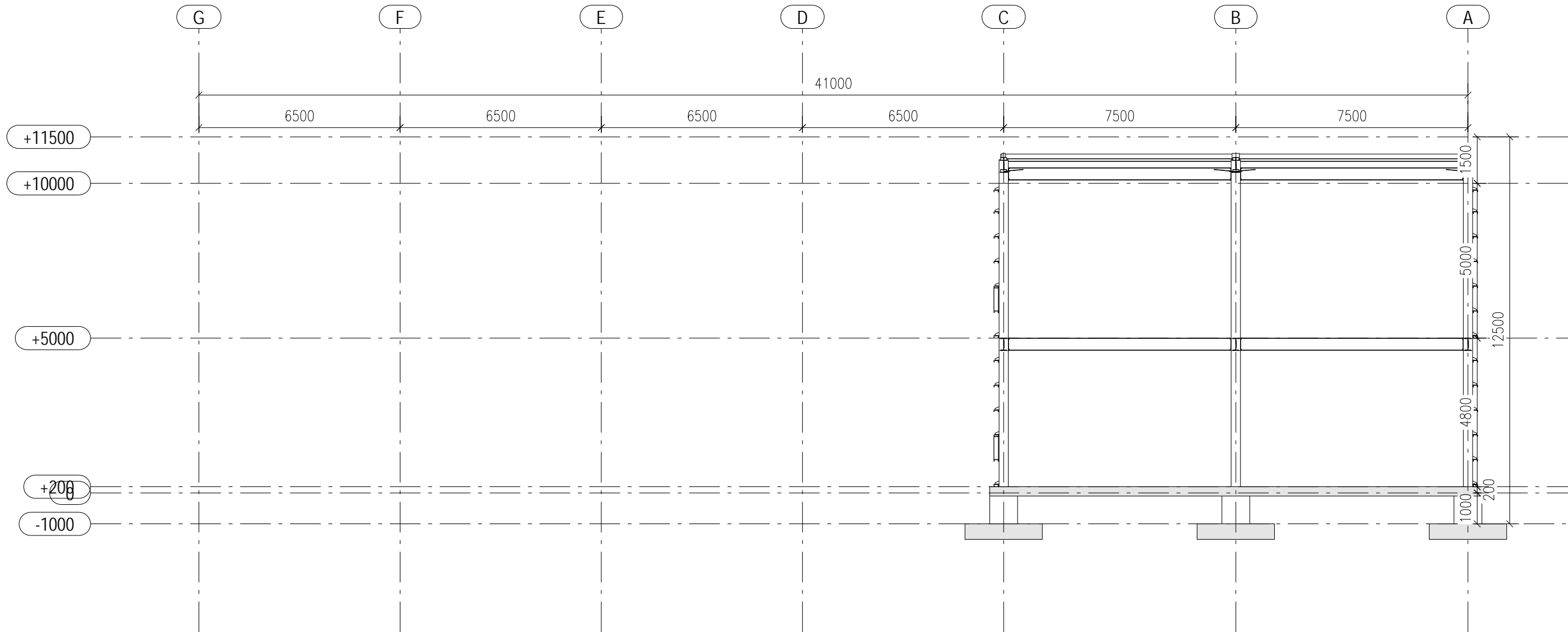

ERECTION
NORTH

POWERED BY  TEKLA A TRIMBLE COMPANY		馳揚數位科技	
DRAWING TITLE	立面圖@LINE 4		
CONTRACT	順億廠房新建工程B棟		
CONTRACT NO	101	ISSUE DATE	
MODELLED BY	馳揚數位科技	REVISION DATE	
DRAW BY	馳揚數位科技	REVISION No.	
CHECKED	馳揚數位科技	DATE	06.08.2018
		DWG. No.	[4]

圖面型鋼清單			
代號	規格	材質	數量
	PL4.5*900	A36	3
	PL12*350	A36	1
	RB13	A36	4
M	C150X50X20X2.3	A36	59
M	RH300X150X6.5X9	SN490B	1
M	RH396X199X7X11	SN490B	10
M	RH488X300X11X18	SN490B	3

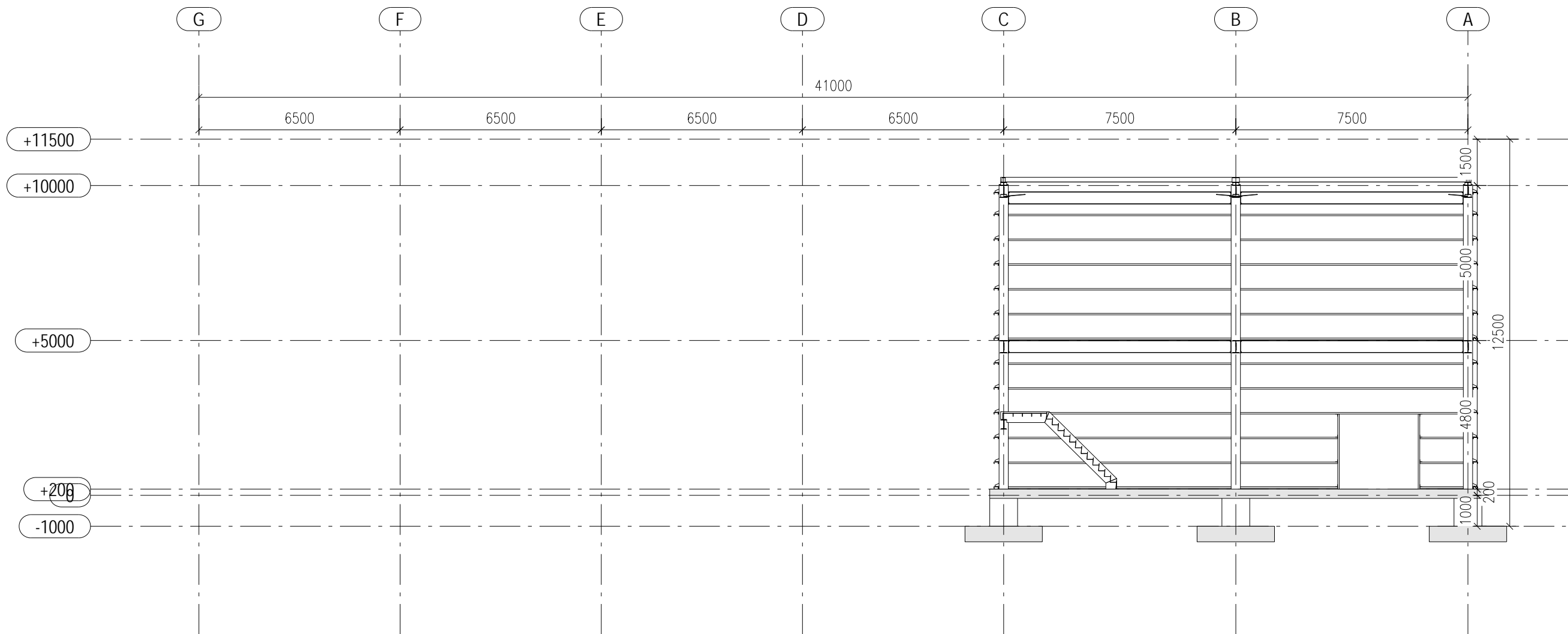

ERECTION
NORTH

POWERED BY  TEKLA A TRIMBLE COMPANY		馳揚數位科技		
DRAWING TITLE	立面圖@LINE 5			
CONTRACT	順億廠房新建工程B棟			
CONTRACT NO	101	ISSUE DATE		
MODELLED BY	馳揚數位科技	REVISION DATE		
DRAW BY	馳揚數位科技	REVISION No.		
CHECKED	馳揚數位科技	DATE	06.08.2018	DWG. No. [5]

圖面型鋼清單			
代號	規格	材質	數量
	PL4.5*900	A36	5
	RB13	A36	8
M	C150X50X20X2.3	A36	125
M	RH300X150X6.5X9	SN490B	9
M	RH396X199X7X11	SN490B	21
M	RH488X300X11X18	SN490B	5

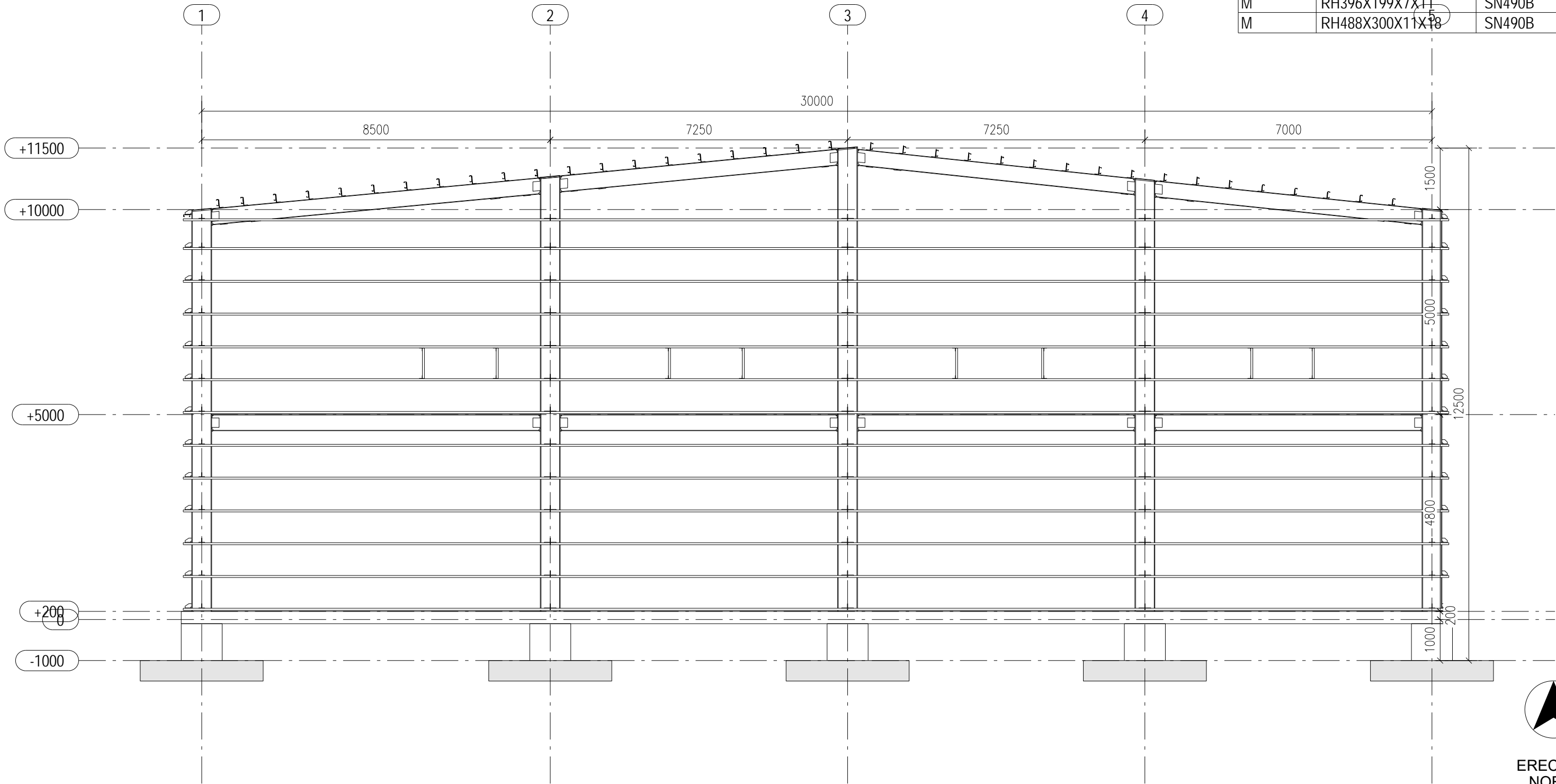

POWERED BY				<h2 style="text-align: center;">馳揚數位科技</h2>	
DRAWING TITLE		立面圖@LINE A			
CONTRACT		順億廠房新建工程B棟			
CONTRACT NO		101	ISSUE DATE		
MODELLED BY		馳揚數位科技	REVISION DATE		
DRAW BY		馳揚數位科技	REVISION No.		
CHECKED		馳揚數位科技	DATE	06.08.2018	DWG. No. [6]

圖面型鋼清單				
代號	規格	材質	數量	
	PL4.5*900	A36	5	
	RB13	A36	16	
M	C150X50X20X2.3	A36	130	
M	RH300X150X6.5X9	SN490B	18	
M	RH396X199X7X11	SN490B	34	
M	7000 RH488X300X11X18	SN490B	5	

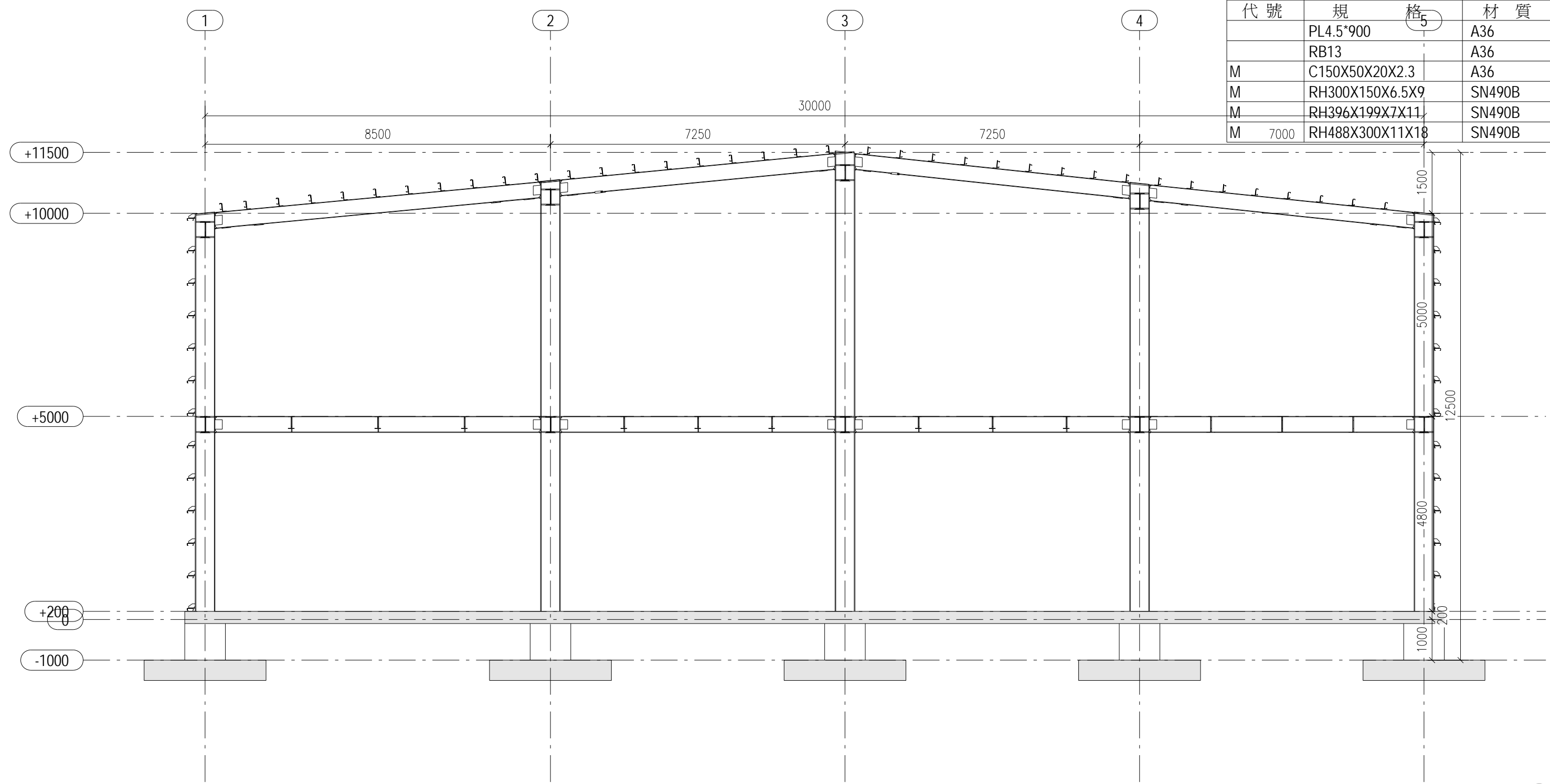

ERECTION NORTH

POWERED BY  A TRIMBLE COMPANY		馳揚數位科技		
DRAWING TITLE	立面圖@LINE B			
CONTRACT	順億廠房新建工程B棟			
CONTRACT NO	101	ISSUE DATE		
MODELLED BY	馳揚數位科技	REVISION DATE		
DRAW BY	馳揚數位科技	REVISION No.		
CHECKED	馳揚數位科技	DATE	06.08.2018	DWG. No. [7]

圖面型鋼清單				
代號	規格	材質	數量	
	PL4.5*900	A36	5	
	PL12*350	A36	2	
	RB13	A36	10	
M	C150X50X20X2.3	A36	155	
M	RH300X150X6.5X9	SN490B	13	
M	7000 RH396X199X7X11	SN490B	25	
M	RH488X300X11X18	SN490B	5	

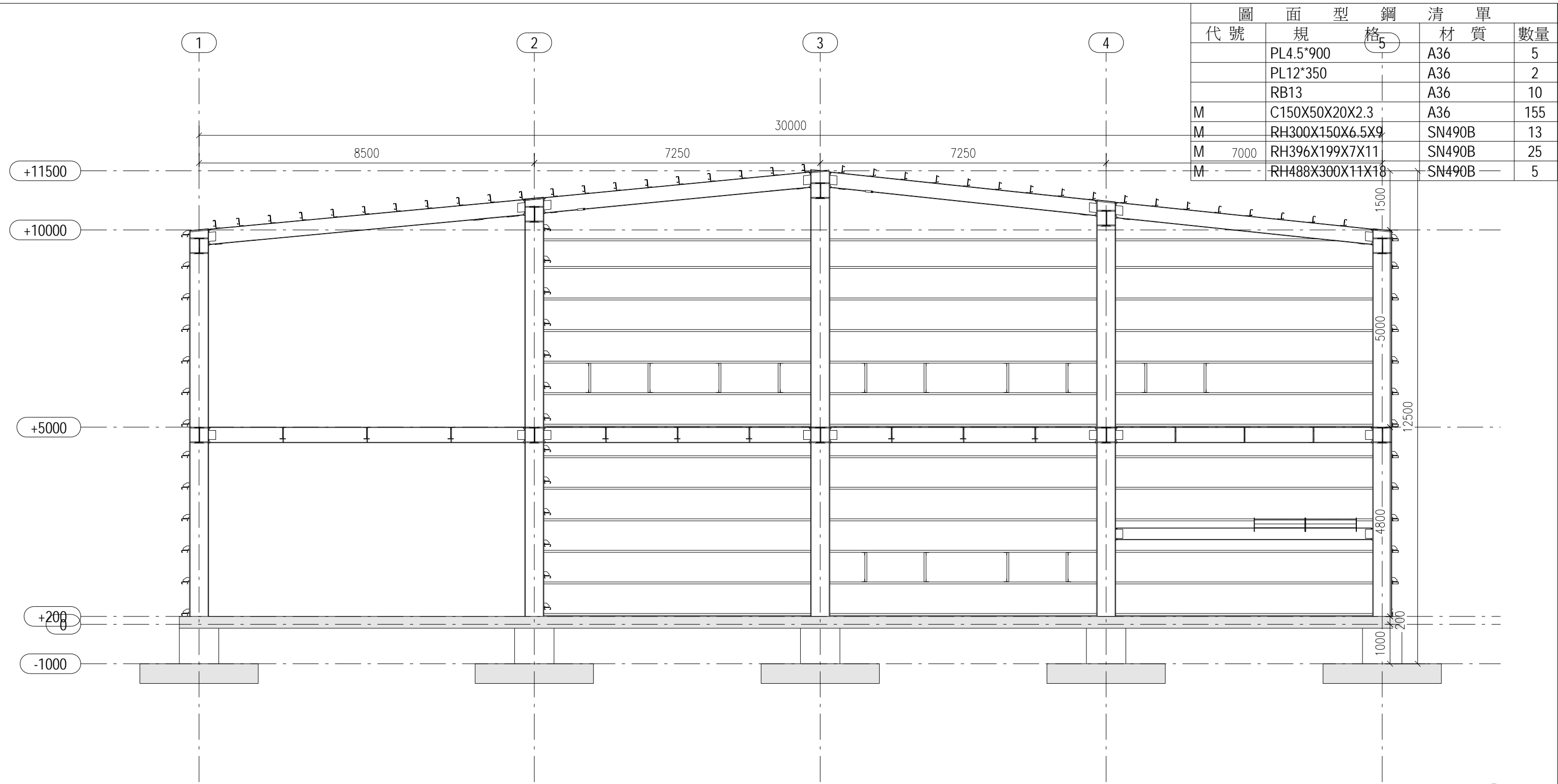

ERECTION NORTH

POWERED BY  A TRIMBLE COMPANY		馳揚數位科技		
DRAWING TITLE	立面圖@LINE C			
CONTRACT	順億廠房新建工程B棟			
CONTRACT NO	101	ISSUE DATE		
MODELLED BY	馳揚數位科技	REVISION DATE		
DRAW BY	馳揚數位科技	REVISION No.		
CHECKED	馳揚數位科技	DATE	06.08.2018	DWG. No. [8]

圖面型鋼清單			
代號	規格	材質	數量
	PL4.5*900	A36	2
	RB13	A36	4
M	C150X50X20X2.3	A36	75
M	RH300X150X6.5X9	SN490B	6
M	RH396X199X7X11	SN490B	10
M 7000	RH488X300X11X18	SN490B	2

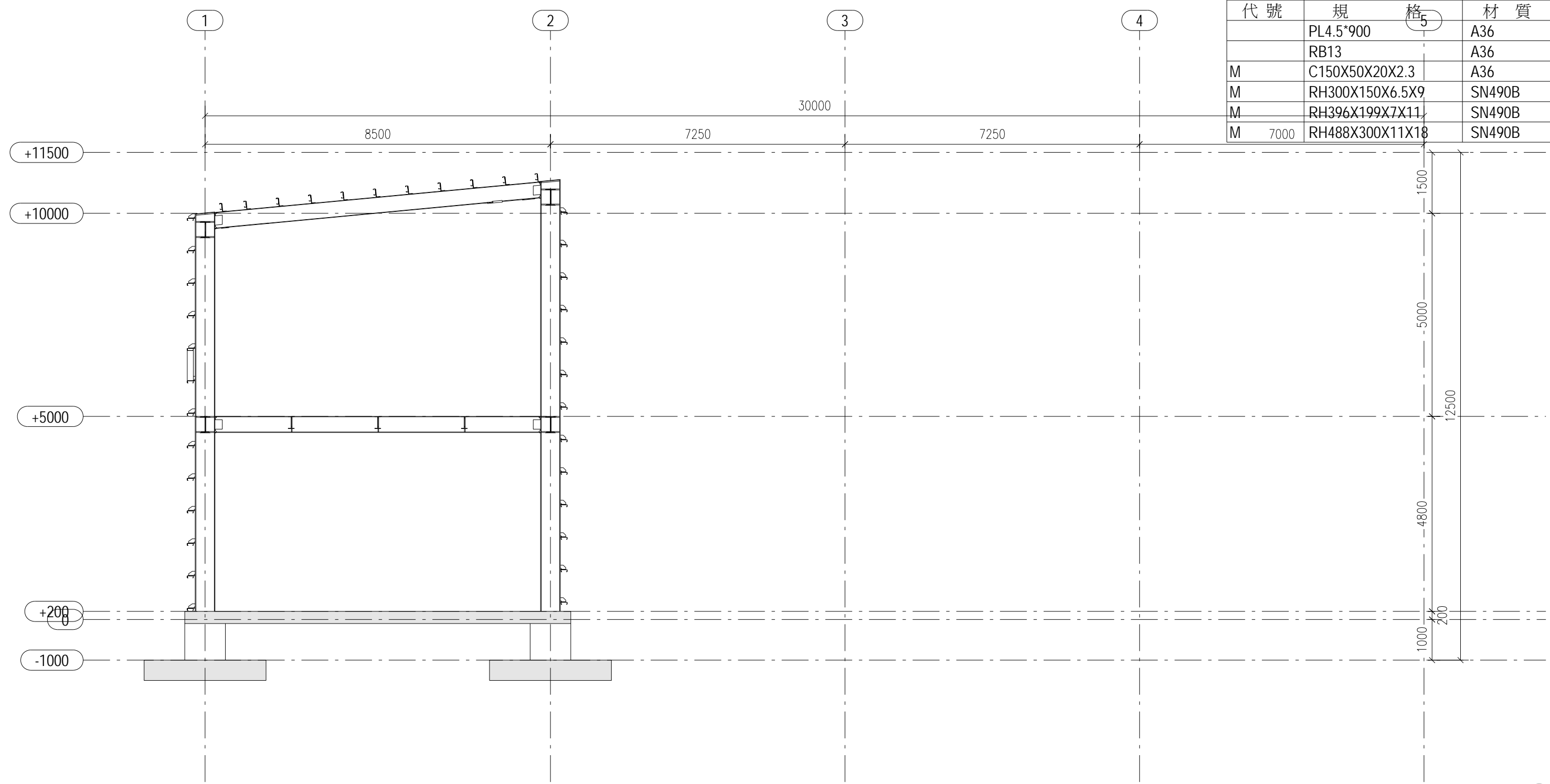

ERECTION
NORTH

POWERED BY  A TRIMBLE COMPANY		馳揚數位科技	
DRAWING TITLE	立面圖@LINE D		
CONTRACT	順億廠房新建工程B棟		
CONTRACT NO	101	ISSUE DATE	
MODELLED BY	馳揚數位科技	REVISION DATE	
DRAW BY	馳揚數位科技	REVISION No.	
CHECKED	馳揚數位科技	DATE	06.08.2018
		DWG. No.	[9]